



DIVERSITECH
Air Pollution Solutions

Operation & Maintenance Manual

FRED CARBO



READ AND SAVE THESE INSTRUCTIONS

Visit our Website for more information on this product

www.diversitech.ca

1200 55th Avenue, Montreal, Quebec H8T 3J8
Tel: 1.800.361.3733 | Fax: 1.514.631.9480 | info@diversitech.ca

Table of Contents

SECTION 1 – SAFETY PRECAUTIONS OF FUME & DUST EXTRACTION/COLLECTION	3
1.1 Symbols	3
1.2 User Responsibility	3
1.3 Fume Extraction Hazards	3
1.4 Dust Collection Hazards	4
1.5 Safety Stickers	4
1.6 Sound Levels	4
SECTION 2 – SPECIFICATIONS	5
2.1 Diagram & Description	5
2.2 Specifications	5
2.3 Filter Specifications.....	6
2.4 Dimensions	7
SECTION 3 – SETUP / INSTALLATION	8
3.1 To Setup or Install Safely	8
3.2 Un-Packaging	8
3.3 Principles of Operation	8
3.4 Selecting a Location	8
3.5 Installation	9
3.6 Preparing Unit for Operation	10
SECTION 4 – OPERATION	10
4.1 To Operate Safely	10
4.2 Controls	10
4.3 Pre-use Checklist	10
SECTION 5 – MAINTENANCE & TROUBLESHOOTING	11
5.1 To Maintain this Product Safely	11
5.2 Tools Required	11
5.3 Routine Maintenance Schedule	12
5.4 Troubleshooting Procedure	13
SECTION 6 – DECOMMISSIONING	14
6.1 To Decommission this Product Safely	14
6.2 Tools Required	14
6.3 Conformity with Recycling Regulations	14
APPENDIX 1A – ELECTRICAL DIAGRAM MANUAL [120 VAC] Single Phase Power	15
APPENDIX 2 – MAINTENANCE RECORD	16
APPENDIX 3 – SAMPLES SAFETY STICKERS	17
NOTES.....	18,19
Limited Equipment Warranty	Back Cover
Freight Claims	Back Cover
Return Material Policy	Back Cover

SECTION 1 - SAFETY PRECAUTIONS OF FUME & DUST EXTRACTION/COLLECTION



READ
BEFORE
USE

This manual contains specific cautionary statements related to worker safety. To protect yourself and others, read this manual thoroughly and follow as directed before use. Not all hazards of fume & dust control are listed in this manual, and no hazards related to welding, cutting, grinding, painting, deburring or other applications are listed. Consult a qualified safety professional.



DO
NOT
USE

Do not use this equipment:

- To collect smoke, fumes, liquid vapors, or aggressive fumes such as acids.
- If the power cord has been damaged or ground (third prong) removed.
- Without a filter.

1.1 Symbols

This manual uses several symbols to highlight specific hazards. Be familiar with these symbols and when you see them in this manual, read adjoining warning text to avoid the hazard.



WARNING!
DANGER!



ELECTRIC
SHOCK



MOVING
PARTS



HOT
PARTS

1.2 Users Responsibility

- Improper use can be hazardous.
- All users must carefully read and understand this instruction manual prior to use
- No objects, such as tools, should be placed on the machine.
- When moving machine, care should be taken to ensure the users feet remain clear of the wheels.
- Motor should not contact any objects, and all motor repairs should be performed while the power switch is off and the power source is disconnected. Operator should not touch motor during use.
- Blower assembly should not contact any objects, and all blower repairs should be performed while the power switch is off and the power source is disconnected. Operator should not touch blower during use.
- For maintenance of any and all components, power switch must be off and the power source disconnected
- It is your responsibility to follow all applicable ANSI, OSHA, UL, CSA, National & Local Fire Codes, and other regulatory guidelines covering the safe use of equipment that extracts fumes, collects dusts, and exhausts filtered air either indoors or outdoors.
- Before use, inspect the unit for damage and verify it is working properly.
- Only qualified persons should install, operate, maintain, or repair this unit.
- Do not modify or repair the unit with parts or accessories not supplied by the manufacturer.
- Consult filter manufacturer's instructions for filter use and reuse, including instructions for cleaning.

1.3 Fume Extraction Hazards

- Breathing smoke, fumes, or dusts produced in applications such as welding, cutting, grinding, painting, deburring are hazardous to user's health. Proper ventilation or use of well maintained fume extraction and/or dust collection equipment helps the user avoid these hazards.
- Breathable contaminants may not be visible or have an odor.
- Stop operation and leave the area immediately if 1) breathing becomes difficult, 2) experience dizziness, 3) impaired vision, 4) or eye/nose/mouth irritation.

1.4 Dust Collection Hazards

- Do not use or install equipment where any potential for combustible fumes or dusts are present, until a qualified person has indicated it is safe to do so.
- Never use or install equipment where the potential for combustible fumes or dusts are present without a fire/explosion protection system.
- If you are unsure if the product you purchased is correct for your application, call Diversitech at 1-800-361-3733.

1.5 Safety Stickers

- This machine is equipped with safety stickers to remind operators of the inherent dangers during use and maintenance.
- The stickers are only reminders, and all safety precautions contained in this manual must be well understood and adhered to by all users.
- See **APPENDIX 5: Sample Safety Stickers** for example of stickers applied to machine.

1.6 Sound Levels



- This machine can emit sound pressure levels in excess of 70dB(A).
- Appropriate ear protection is required when the machine is running.
- Sound levels are highest directly in front of the machine.
- The machine must be turned OFF when performing any maintenance on the machine.
- Extended exposure to sound pressure levels greater than 85dB(A) can cause permanent injury to the ears.
- Users should be conscious of the danger and refrain from placing the ear near the silencer outlet.

SECTION 2 - SPECIFICATIONS

2.1 Diagram & Description

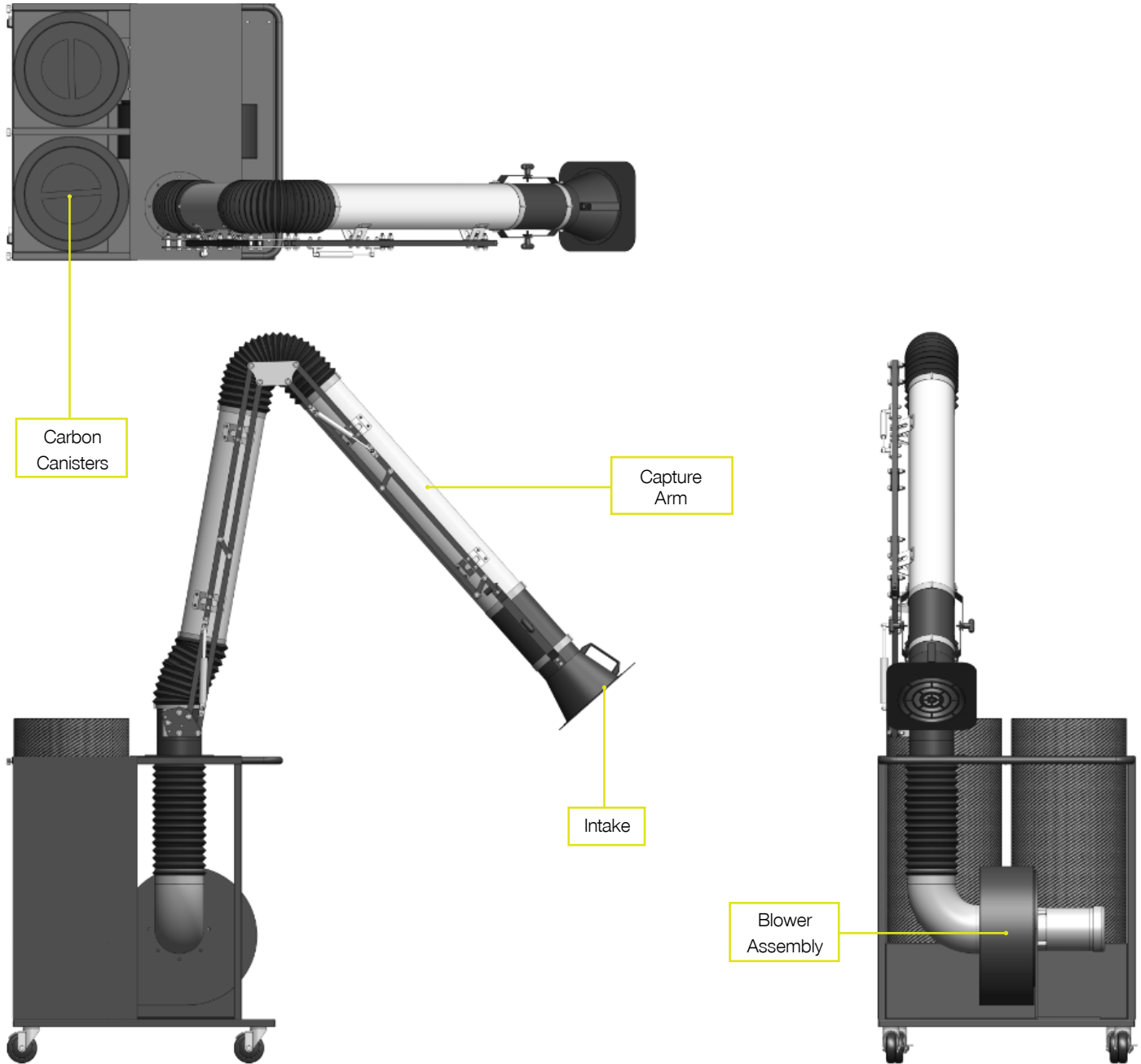

2.2 Product Specifications

Model	Motor (H.P.)	Power		Airflow (CFM)	Carbon Capacity (lbs.)
		Phase (hz)	@120V (amps)		
FRED CARBO VOC Extractor with externally articulated manual capture arm					
FRED CARBO	1.0	1P/60Hz	16	650	150

2.3 Filter Specifications

Description	Part #	Filter Media	Weight	Height	Cleaning Method
Reversible Carbon Canister	S-CCX-75R	Activated Carbon	66 lbs.	30"	Reusable

For information on inspecting and cleaning filter, or purchasing replacement filters, contact Diversitech at 1-800-361-3733.



Convenient elastic band easing installation of media prefilter.



High porosity virgin extruded activated carbon 4 mm. Specially designed to remove VOC. 66 mm bed thickness



High capacity prefilter
 •20mm thickness
 •Low air resistance
 •Antibacterial
 •High capacity: 670g/M²
 •Flame retardant



Parts made of high impact resistant polycarbonate. High quality galvanized steel.



Twist lock Flange. No tools required.



Rubber gasket to ensure air tight fitting.



Twist lock End Cap. No tools required.

2.4 Dimensions

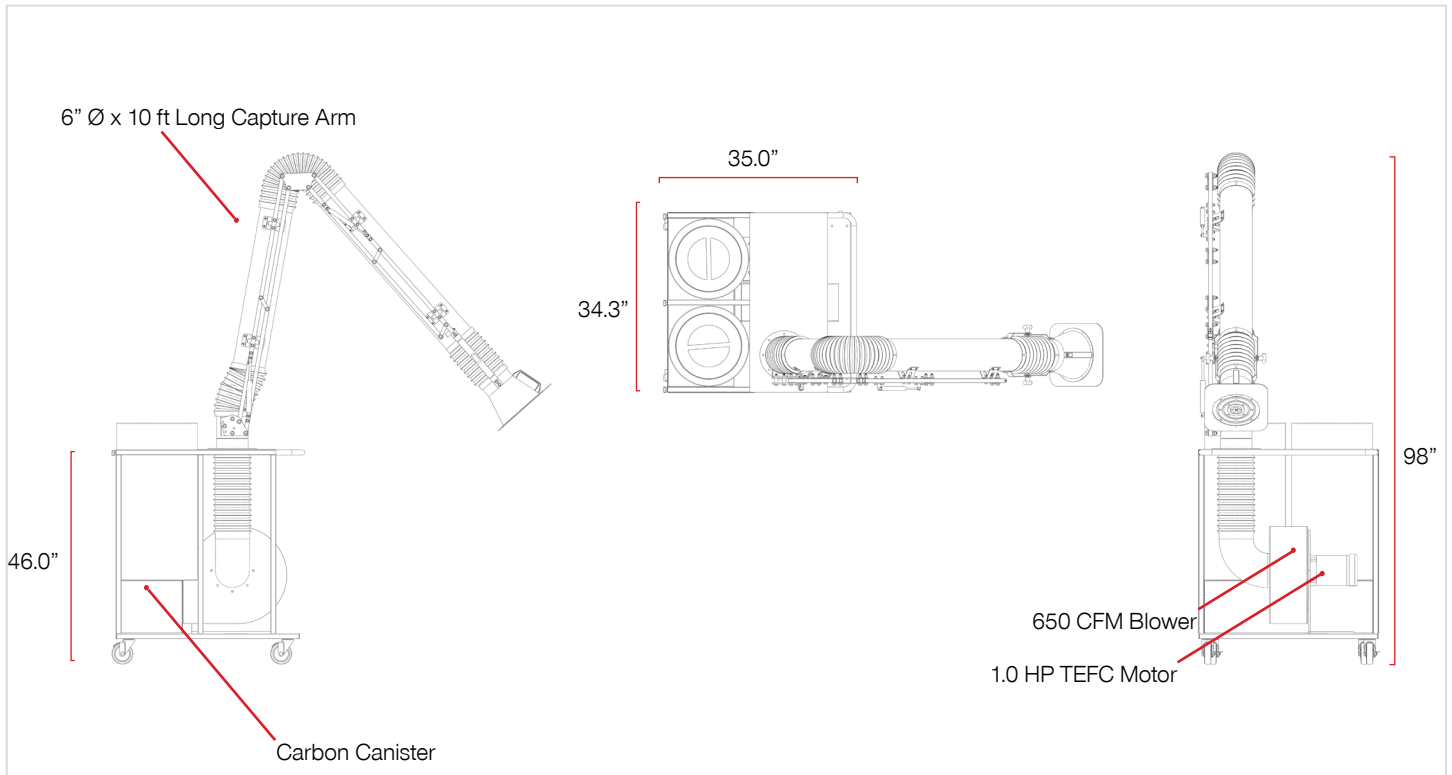

SECTION 3 - SETUP / INSTALLATION

3.1 To Setup or Install Safely



- Do not place unit near flammables or combustible surface.
- Refer to **SECTION 2: Specifications**, to know the electrical requirements of the unit you are installing and ensure adequate input power that is properly sized, rated, and protected.
- This unit must be grounded for safe operation.

3.2 Un-Packaging

1. Immediately upon receiving the unit, carefully examine the carton for damage during transit.
2. Use lift forks to move.
3. Remove packing material.
4. Avoid tipping or inverting during handling.
5. The item serial number, model, and electrical ratings are listed on the nameplate. Record this information in the Maintenance Record provided in **APPENDIX 2: Maintenance Record**, or your own preventative maintenance system.

3.3 Principles of Operation

This product is designed to capture volatile compounds from certain industrial applications. When operating, air is drawn into the capture arm, and, into the Carbon Canisters, and then finally exhausted out.

This product consists of four basic components:

1. A structure for housing all components
2. A motor blower assembly
3. Electrical assemblies
4. Carbon Canister(s)

In air pollution control, adsorption is employed to remove volatile organic compounds (VOCs) from low to medium concentration air streams. Adsorption itself is a phenomenon where air molecules passing through a bed of solid particles are selectively held there by attractive forces. The Carbo unit uses twin carbon cylinders that contain either 50lbs or 75 lbs each. Air sampling is recommended to effectively determine when the carbon is saturated. This saturation point will depend on frequency of use and the concentration of VOC being pulled through the carbon canisters.

The Diversitech Canisters are shipped ready for installation with the activated carbon pre-installed. The Carbo system should be as close to the emission source as possible.

Once the carbon reaches a certain VOC content, saturation, the unit should be shut down and the canister should be replaced. The old carbon or canister is then returned to a reclamation center or disposed of following local environmental laws and guidelines.

When controlling organic compounds, it is recommended that the humidity be maintained below 50%. Higher levels of humidity will fill the carbon pores and reduce the carbon's ability to adsorb the emissions.

3.4 Selecting a Location

- Choose a location where the unit will be used, near the operator.
- Choose a location sufficiently close to a grounded power source.

3.5 Installation

Each machine is wired for correct rotation. Should you need to service the unit's motor, upon restart, make sure that the motor is turning in the right direction, as marked on the motor.



If not already installed, install the carbon canisters onto the plenum. The canisters are held in place with a safety bar to prevent any accidental tipping. Once in place install the safety filter around the canister.

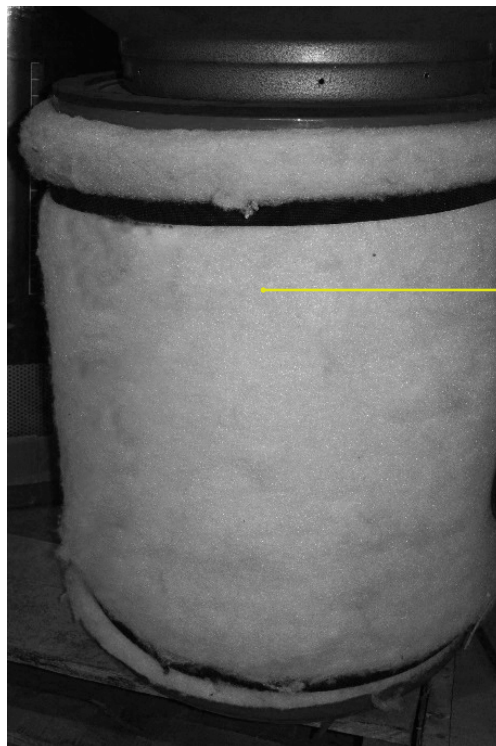

3.6 Preparing Unit for Operation

- Before plugging unit in to an input power source, look at the manufacturer's label located on the exterior of the unit and ensure the source is correctly sized in terms of Voltage and Amperes.
- Check that the Carbon filter is properly installed.
- Prior to use in your application, turn the unit ON, and perform a function test. To do so:
 1. Turn switch to ON position for a few seconds to check that the motor rotation is correct.
 2. LOOK: Is the unit level, stable, and that nothing is obstructing the extraction path.
 3. Start the unit
 4. LISTEN: Does the motor and suction sound smooth and within expected volumes.
 5. FEEL: Place your hand on top of the unit and sense for unexpected vibration. Place your hand in front of the intake hood/surface and sense for expected level(s) of suction.
- Inform all potential users of this equipment where they may find and review this manual.

SECTION 4 - OPERATION

4.1 To Operate Safely



- Read and understand **SECTION 1: Safety Precautions** and **SECTION 4: Operation** before use
- Read and understand all Material Safety Data Sheets and Manufacturer's instructions of all process materials, consumables, and equipment used in conjunction with this equipment.
- Keep away from all mechanical moving parts including motor, gears, and other pinch points.
- Do not use product without first confirming if a Spark Arrestor is required and installed for the type of dust, or fumes you are extracting and/or collection. If you are unsure, call a Diversitech representative at 1-800-361-3733.

4.2 Controls

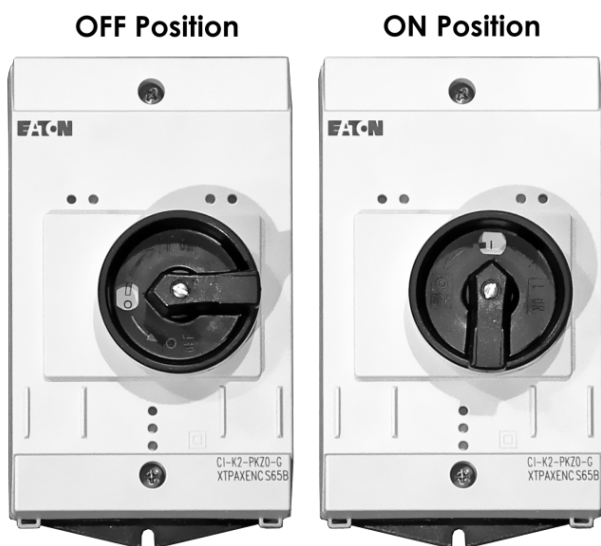

4.3 Pre-Use Checklist

- Read and understand **SECTION 1: Safety Precautions** and ensure **SECTION 3: Installation** has been followed.
- Before plugging unit in to an input power source, make sure that the capture arm is not interfering with adjacent equipment or personnel.
- Before collecting fumes, VOC, or other contaminated air, consult your Diversitech representative to make sure that you have the right carbon canister for the intended use.

SECTION 5 - MAINTENANCE & TROUBLESHOOTING

5.1 To Maintain this Product Safely



- Read and understand SECTION 1: **Safety Precautions** and SECTION 4: **Operation** before maintenance.
- Do not breathe the dust collected from product while changing/cleaning filters or performing maintenance on this product.



- Disconnect power before performing any maintenance on unit, including filter inspection. The input power to this unit is high voltage, and touching any live electrical parts can cause fatal shocks or severe burns. Do not touch live electrical parts.



- Keep away from all mechanical moving parts including motor, gears, and other pinch points while operating.



- Operating this unit causes some parts to heat to a point that will burn bare hands. Before maintenance allow parts to cool, or use proper tools and personal protection equipment during maintenance.

5.2 Tools Required



EYE
PROTECTION



RESPIRATOR



GLOVES



WASTE
CONTAINER

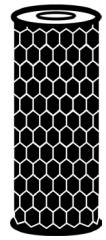

REPLACEMENT
FILTER
(if required)

5.3 Routine Maintenance Schedule

The manufacturer recommends the following routine maintenance based on light-duty use in normal operating conditions. Service more frequently if the unit is used in severe conditions.

Frequency	Manual Reference
Pre-Use	4.3
<ul style="list-style-type: none">• Perform pre-use inspection to ensure operating correctly.	
Daily Inspection	
<ul style="list-style-type: none">• Inspect all equipment surfaces for dust buildup, and wipe down as needed.• Inspect carbon filters for signs of dust buildup, and service as needed.• Check that the gasket between the housing and the carbon canister is not damaged.• Turn unit on, and adjust the capture arm distance to the source so as to capture the maximum amount of fumes.	
As Required – Replace Filter	
<ol style="list-style-type: none">1. Replace after-filter media when it appears torn or dirty.2. Replace Carbon canisters after air sampling or every 6 months depending on usage and concentration of fumes being collected.	
Every (12) months Inspect Basic Components	
<ol style="list-style-type: none">1. Clean unreadable labels and exterior surfaces.2. Wash cabinet internal assemblies with warm water mixed with mild detergent (Allow 12 hours to dry before use).3. Inspect controls for loose wiring.4. Examine motors for signs of unusual wear.	

5.4 Troubleshooting Procedure

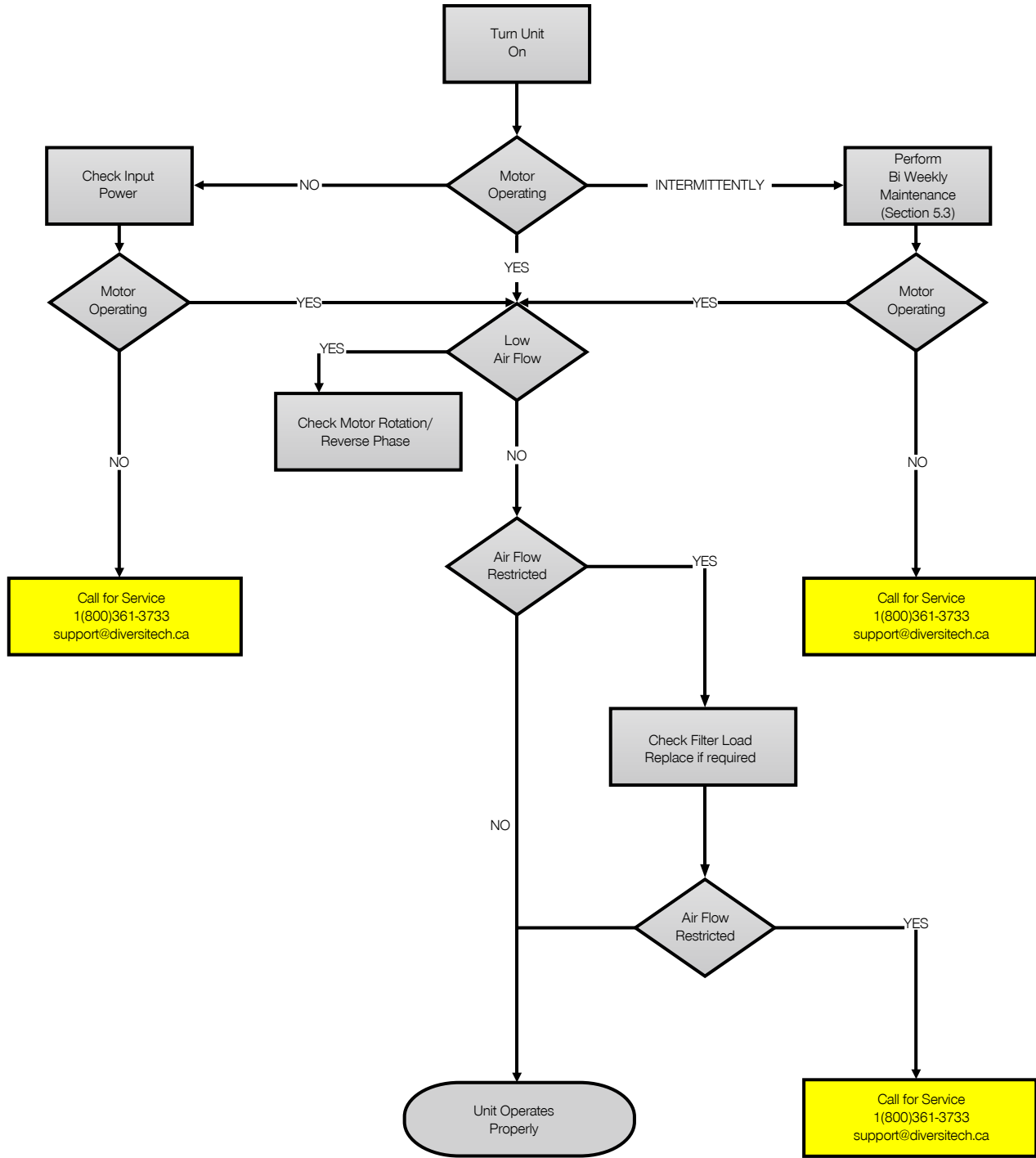

SECTION 6 - DECOMMISSIONING

6.1 To Decommission this Product Safely



- Read and understand **SECTION 1: Safety Precautions** and **SECTION 4: Operation** before maintenance.
- Do not breathe the dust collected from product while changing/cleaning filters or performing maintenance on this product.



- Disconnect power before performing any maintenance on unit, including filter inspection. The input power to this unit is high voltage, and touching any live electrical parts can cause fatal shocks or severe burns. Do not touch live electrical parts.



- Keep away from all mechanical moving parts including motor, gears, and other pinch points while operating.



- Operating this unit causes some parts to heat to a point that will burn bare hands. Before maintenance allow parts to cool, or use proper tools and personal protection equipment during maintenance.



- Machine must be turned off when performing any maintenance.
- Appropriate ear protection is required according to jurisdiction.

6.2 Tools Required

1. Combination wrench set
2. Socket Wrench set
3. Screwdriver set

These tools above are required for unit dismantling.

6.3 Conformity with Recycling Regulations

- All dismantling procedures should be made in compliance with appropriate laws governing the recycling and disposal of materials.
- This machine may contain, but is not limited to:
 1. Steel
 2. Plastic
 3. Rubber
 4. Electrical Conductors
 5. Aluminum
 6. Paint
 7. Carbon Filter
 8. Dust and Debris from use

APPENDIX 1A - ELECTRICAL DIAGRAM MANUAL

[120v] Single-Phase Power



**ELECTRIC
SHOCK
HAZARD**

Disconnect power before performing any maintenance on unit, including filter inspection. The input power to this unit is high voltage, and touching any live electrical parts can cause fatal shocks or severe burns. Do not touch live electrical parts.

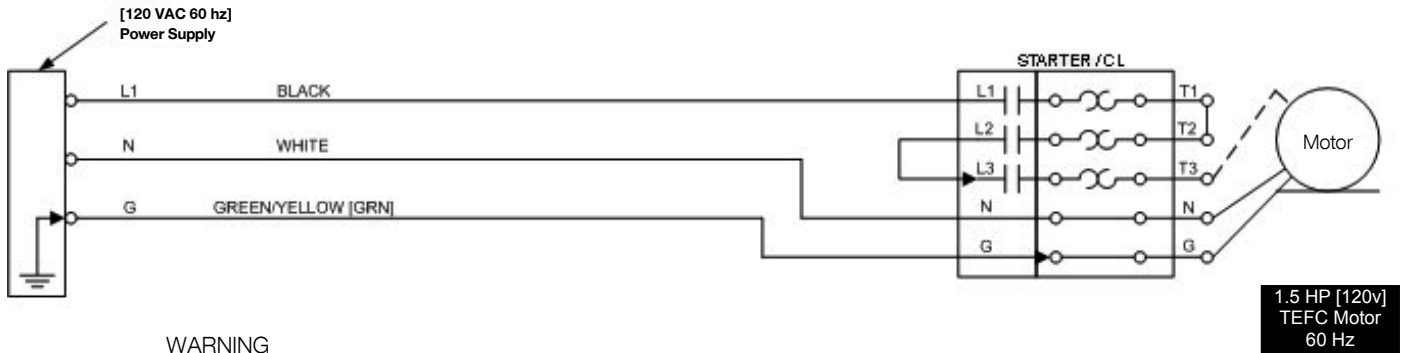

WARNING

Do not route auxiliary contact cable in the same conduit as motor cable

NOTE

Specific transformer wiring may differ depending on voltage configuration.

Units in brackets [] refer to imperial system values

APPENDIX 2 - MAINTENANCE RECORD

Diversitech Inc. authorizes this page to be photocopied or otherwise reproduced as needed for management of maintenance records.



MANUFACTURER:	DIVERSITECH INC.	MODEL N°	FRED-CARBO	SERIAL N°	
SERVICE LOCATION:				CONTROL N°	

Date	Description of Service	Serviced By	Location	Comments





Only use manufacturer approved replacement parts on this unit.

APPENDIX 3 - SAMPLE SAFETY STICKERS

The machine is marked with a wet filtration safety sticker to remind the operator of safe working practices:

WARNING	AVERTISSEMENT	ADVERTENCIA	WET FILTRATION
DO NOT USE this equipment:	NE PAS UTILISER cet équipement :	NO USAR este equipo:	
 <ul style="list-style-type: none"> To collect smoke, fumes, liquid vapors, or aggressive fumes such as acids 	<ul style="list-style-type: none"> Pour l'extraction de fumées ou d'émanations de plus de 82 °C / 180 °F. 	<ul style="list-style-type: none"> Para extraer humo o gases superiores a 180°F / 82°C. 	
 <ul style="list-style-type: none"> If the power cord has been damaged or ground (third prong) removed. 	<ul style="list-style-type: none"> Si le cordon d'alimentation est endommagé ou si la mise à la terre (troisième broche) a été retirée. 	<ul style="list-style-type: none"> Si el cable está dañado o se le ha quitado el tierra (tercera punta). 	
 <ul style="list-style-type: none"> Without the proper water level in basin 	<ul style="list-style-type: none"> Si le niveau d'eau dans le bassin n'est pas adéquat. 	<ul style="list-style-type: none"> Sin el nivel de agua adecuado en el depósito. 	

The machine is marked with safety stickers in appropriate places to remind the operator of safe working practices.

STICKERS APPLIED TO MACHINE				
Figure 1	Figure 2	Figure 3	Figure 4	Figure 5
Foot Trap Hazard	Falling Objects Hazard	Moving Parts Hazard	Electric Shock Hazard	Loud Noise Hazard
 <p>CAUTION</p> <p>FOOT TRAP HAZARD PROPER FOOTWEAR REQUIRED</p>	 <p>CAUTION</p> <p>FALLING OBJECTS HAZARD DO NOT PLACE OBJECTS ON MACHINE</p>	 <p>CAUTION</p> <p>MOVING PARTS HAZARD DO NOT TOUCH - DISCONNECT POWER BEFORE OPENING</p>	 <p>CAUTION</p> <p>ELECTRIC SHOCK HAZARD SERVICE BY TRAINED PERSONNEL ONLY</p>	 <p>CAUTION</p> <p>LOUD NOISE HAZARD WEAR EAR PROTECTION DURING OPERATION</p>

LIMITED EQUIPMENT WARRANTY

For a period of 2 years from the date of purchase, all Diversitech products are warranted to be free from defects in material, workmanship, and construction, when used in accordance with installation, maintenance instructions, and expressly stated proper use application(s). Diversitech Inc. will repair or replace, at our option, any defective parts which fail during the warranty period. This warranty is limited to replacement parts ONLY, and does not cover personal liability, property loss, normal wear; and does not cover losses resulting from (or due to) improper installation, inadequate maintenance, misapplication, misuse, or use above rated capacities.

FREIGHT CLAIMS

Shipments must be inspected upon arrival. All Diversitech units are sold ex-plant. Therefore, it is the receiver's responsibility to file any freight claims with the carrier for obvious or concealed damages. Damaged shipments must be refused at time of receipt, by consignee.

RETURN MATERIAL POLICY

Prior to the return of material, for whatever reason, a return manufacturing authorization number (RMA#) is required from the Diversitech customer service department. This procedure is necessary for proper control and handling of returned materials. Call 1-800-361-3733 or email support@diversitech.ca to obtain an RMA.

All material must be returned prepaid. Credit will be given for returns for warranty repair or replacement. Freight collect shipments, or freight without an RMA, will not be accepted. It is the shipper's responsibility to ensure that material being returned to Diversitech is adequately packaged for shipment to preclude damages.



Visit our Website for more
information on this product
www.diversitech.ca

1200 55th Avenue
Montreal, Quebec H8T 3J8
Email: info@diversitech.ca