

Operation & Maintenance Manual

AIRHAWK DUST COLLECTOR

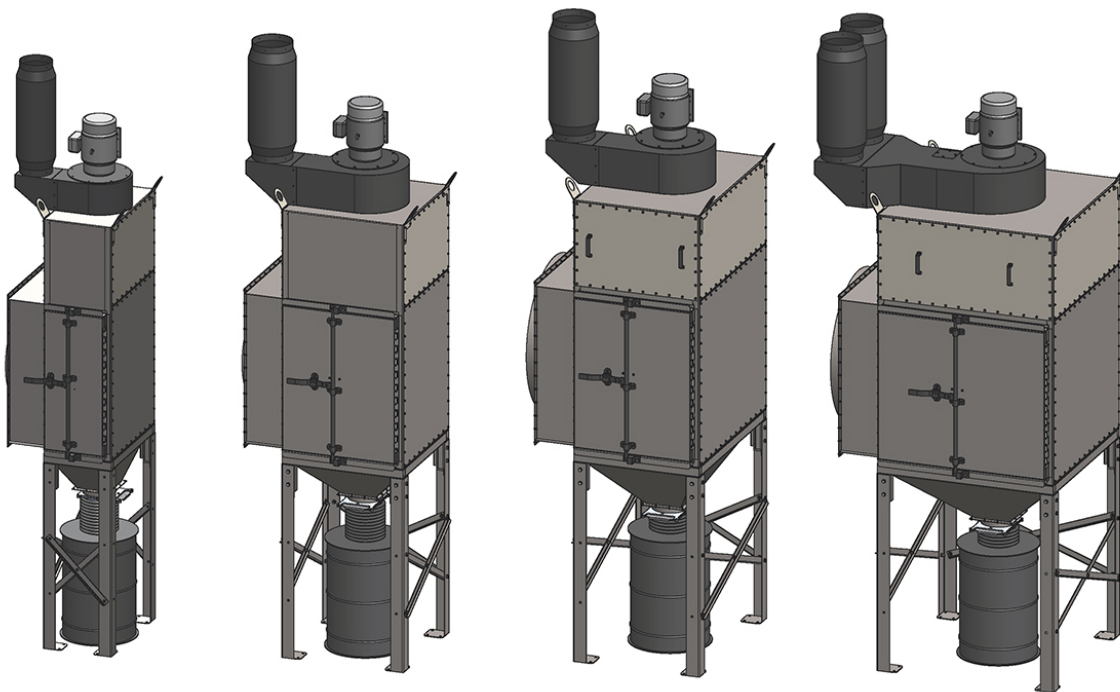

Visit our Website for more information on this product
www.diversitech.ca

1200 55th Avenue, Montreal, Quebec H8T 3J8
Tel: 1.800.361.3733 | Fax: 1.514.631.9480 | info@diversitech.ca

TECHNICAL MANUAL FOR AIR HAWK DUST COLLECTOR

1 INTRODUCTION

This technical manual explains how to receive, assemble, install, operate, and maintain your Diversitech Air Hawk filter system. All team members must read this manual in its entirety before receiving, installing, operating, or maintaining your Air Hawk. All team members must comply with all instructions in this manual. Failure to do so may result in a voided product warranty. While every attempt has been made to produce a comprehensive guide, this technical manual cannot cover every possible circumstance. As a result, additional safety precautions, employee training, equipment, and steps may be required depending on your specific scenario.

This technical manual is intended for use with the Diversitech Air Hawk filter system only. Additional tasks are required to receive, install, operate, and maintain the Air Hawk that are not covered in this guide. Additional tasks include, but are not limited to, electrical work, mechanical work, the operation of heavy equipment, and adhering to safety procedures. All work must comply with industry standards and local, state, and federal government laws, codes, and policies.

The Diversitech Air Hawk filter system cleans dust out of the air, resulting in a safer work environment. Your Air Hawk system is made of quality materials and by professional personnel. The Air Hawk's operational ability is verified before installation.

It is important to completely understand this entire manual before your Air Hawk arrives because steps are included to ensure that no parts are missing or damaged during reception of your product, and policies for reporting shipping and receiving issues. Please note that local codes, ordinances, and laws may alter installation of your device in your location.

If you have any questions, please contact your Diversitech representative, or contact Diversitech at 1-800-361-3733.

2 SAFETY

2.1 Safety statement

Diversitech provides a range of air cleaning equipment. Some are compact and simple to maneuver. Others are large, heavy, multi-component assemblies that are challenging to move and require the use of rigging, heavy machinery, and more. Your Air Hawk requires connections for electricity and compressed air, and the area must be safe for the use of equipment with high rotations per minute (RPM) such as fan blades.

Safety is the highest priority for everyone. The on-site personnel responsible for the Air Hawk must understand the equipment and develop a plan to safely handle reception, installation, operation and maintenance of the Air Hawk before it arrives. Dust collection equipment involves riggers, electricians, installers, operators, maintenance staff, and more. The on-site personnel must ensure all team members have the necessary training and understanding of the equipment. Follow all health, safety, and environmental (HSE) regulations at all times.

2.2 Safe Work Practices and Staff Training

Diversitech sets safety at the highest priority for their team members and customers. The following guidelines are part of Diversitech's ongoing efforts to make safety priority one in the workplace:

- All team members receive safety training relevant to their work site, task load, and environment.
- Supply safety equipment and apparel to all team members, such as head protection, harnesses, hand and footwear, eye and ear protection.
- All team members working with the Air Hawk at any stage or in any way receive relevant training and work only under direct supervision of experienced leadership.
- Supply all tools and equipment necessary to work safely and efficiently.
- Lighting is adequate for all team members in all work environments.
- The work zone is signed, taped-off and clearly marked to stop unauthorized entry. If the perimeter blocks or interferes with other work areas or traffic routes, then barriers and qualified personnel will direct traffic.
- Only team members directly involved in the current work task are present inside the work zone. Before receiving, installing, operating, or maintaining this piece of equipment, you must read and understand this manual. It is a matter of safety for you and everyone around you. Your Air Hawk has parts that move quickly which can cause serious injury or death. If you do not understand anything in this manual, do not proceed. Contact your supervisor and make sure you fully understand every component of your task before moving forward.

Never operate your Air Hawk if factory-installed guards are missing or damaged. Always replace damaged or missing guards.

2.3 Safety Precautions

2.3.1 Warning Decals

Your Air Hawk has warning decals in various locations. It is the owner and operator's responsibility to ensure that all operators are aware of them, understand them, and they remain visible and readable at all times.

2.3.2 Safety Guards

Your Air Hawk may have one or more safety guards to protect people from injury. It is the owner and operator's responsibility to ensure that the guards are properly maintained and present during operation.

2.3.3 Lock-Out/Tag-Out

Your Air Hawk must meet all standards and regulations put forth in OSHA Standard 1910.147, "Control of Hazardous Energy (Lock-Out/Tag-Out)." OSHA Standard 1910.147 "requires employers to establish a program and utilize procedures for affixing appropriate lock-out / tag-out devices to energy isolating devices and to otherwise disable machines or equipment to prevent unexpected energizing, start-up or release of stored energy to prevent injury to employees."

Before servicing or inspecting your Air Hawk, complete a Lock-Out/Tag-Out procedure in compliance with OSHA Standard 1910.147 on all electrical and compressed air sources, and any other energy source. If you have any questions or require further information, refer to OSHA Standard 1910.147 or contact your Safety Director.

3 Receiving Your Air Hawk

3.1 Customer and Carrier Responsibilities

Inspect all equipment before moving it from the vehicle. Photograph and log any damage or defects. Large dents reduce the strength of the housing. Notify Diversitech immediately of any structural damage. It is the purchaser's responsibility to file damage claims and report missing parts with the carrier and your Diversitech representative. During transit, any equipment damage is the carrier's responsibility unless otherwise noted beforehand.

The Diversitech Air Hawk is not assembled before shipping and must be assembled by installation personnel. The Air Hawk requires common hand tools for assembly. Heavy equipment, such as a crane, forklift, and a chain-fall, are needed to lift and place some components, such as the fan and motor located on top of the unit. You must install, connect, and verify the safe operation of all electrical, water, air connections, and regulation equipment.

3.2 Uncrating and Inspection

Diversitech Air Hawk units ship in multiple containers. One container contains the filter module assembly. A second container holds the hopper(optional) section. The remaining containers hold the fans, structural components, airlocks, safety monitoring filters, and custom accessories.

Verify that all of the items listed in the Bill of Loading have been received and are present in your containers. The exact list of components included with your Air Hawk depends on the specifics of your purchase, and may include:

4 Installation of Your Air Hawk

4.1 Tools for Assembly

In the interest of workplace safety, ensure only authorized team member service or maintain electrical and safety components. Air Hawk installation requires the following equipment:

- SAE socket wrench set
- Screwdriver sets
- Impact wrench
- Hammer drill
- Masonry bit
- Floor anchors
- Wire cutters
- Wire nuts
- Electrical tape
- Electrical conduit

- 1/2" or larger black iron pipe or equivalent compressed air connections
- Thread sealant
- Forklift
- Overhead Hoist
- Level

5 Assembling Your Diversitech Air Hawk

5.1 Hardware

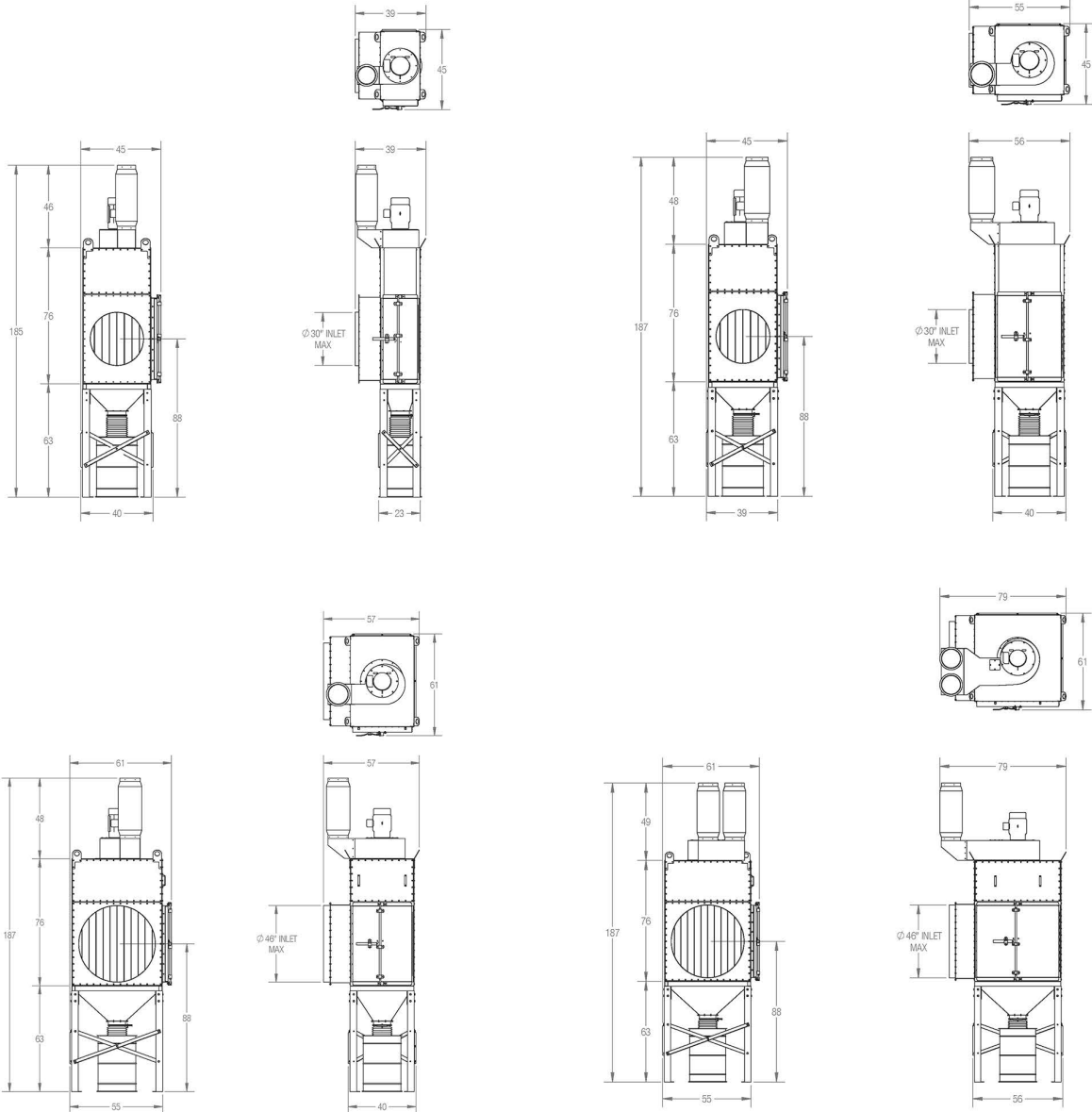

5.2 Drawer System or Optional Hopper and Support Leg Assembly



The Drawer system is factory installed and required no further assembly.

Follow these steps to locate and install the hopper units.

- 1) Find the hoppers and support legs.
- 2) Move the hoppers to a level surface. In the case of a multi-hopper system, use the configuration guide in the General Drawing to place them.
- 3) Square the hoppers.
- 4) Using the corner support brackets, bolt the hoppers together as shown.

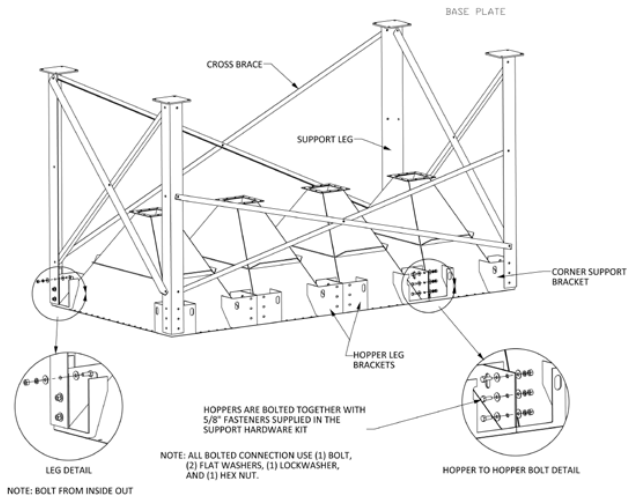

- 5) Once the hopper and support leg assembly is complete, turn the assembly over into a standing position. Heavy machinery is required, such as a forklift or chain hoist. There are slots for lifting located in the corner support brackets.
- 6) Using heavy machinery, carefully rotate the completed hopper and support leg assembly into a standing position. Ensure that all inspection panels and connections are oriented properly.
- 7) Level the hopper flange(s).
- 8) Using concrete anchors, secure the support legs to the floor.

5.3 Filter Module Assembly

When assembling the filter module, there are several precautions to keep in mind:

- Always keep the entire weight of your collector supported by heavy machinery, such as a crane or forklift, until all bolts have been installed and tightened.
- It may be necessary to use alignment pins or a drift to align holes.
- When inserting bolts, start at the corners and move to the center of the collector. Do not tighten bolts when aligning the hopper. Small adjustments may be necessary, which are not possible when the bolts are tightened. Wait until all bolts are aligned, inserted, and started before tightening.



5.4 Discharge Assembly (optional)

The hopper discharge assembly is a large drum with either a sliding gate or a rotary airlock, depending on your accessory.

- 1) Find the hopper discharge assembly.
- 2) Install the accessory to the hopper discharge flanges using the General Drawing.
- 3) Thoroughly clean the top surface of the gate flange and apply rope caulk
- 4) Before attaching the slide gate, ensure that the installation location and orientation does not hit the support bracing when pulled out.
- 5) Attach the slide gate with bolts to the hopper discharge flange.
- 6) Cover the drum with the lid.
- 7) Put the drum latching ring over the top of the drum, so it lies over the drum lid.
- 8) Ensure the clamp is not upside down.
- 9) Put one end of the flex hose over the drum's collar and secure with a hose clamp.
- 10) Put the barrel assembly under the hopper and put the other end of the flex hose onto the slide gate's collar. Secure it with a hose clamp.
- 11) Open the slide gate.

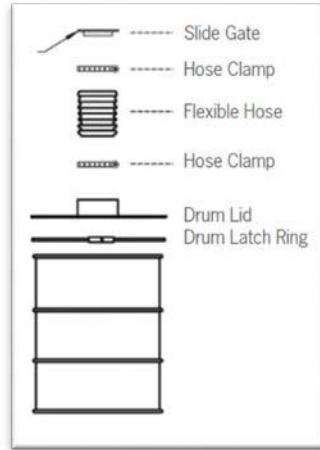

5.5 Inlet Duct Design

Duct work design is dependent on the unique location of your Air Hawk. Use these guidelines when customizing an installation solution for your specific location.

- 1) The air duct connection to the inlet flange should be straight and at least 2 duct diameters.
- 2) 60 degrees is the minimum angle from the duct to the inlet flange.
- 3) This example shows a recommended design. Note that the angle from the duct to the inlet flange is 90 degrees, above the sixty-degree minimum, and the horizontal length is at least 2 duct diameters to distribute dust evenly.

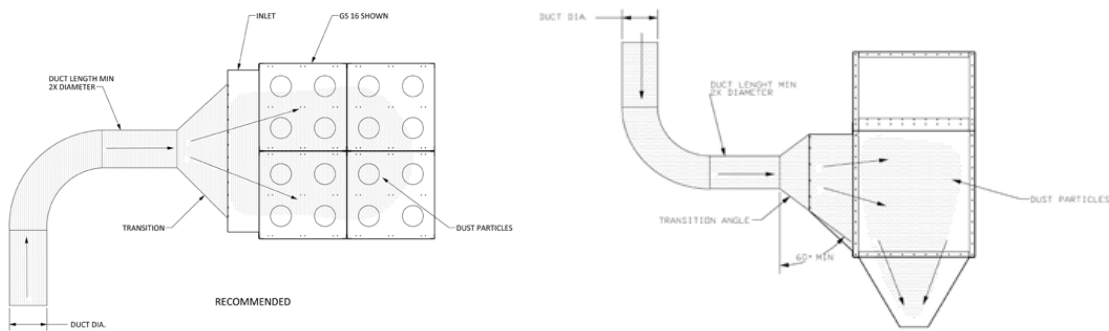

- 4) The following examples are not recommended: note that the duct enters the inlet flange at 0 degrees, below the 60-degree minimum. As a result, previously filtered dust re-enters the air stream. In Figure 2, the duct is not long enough and bends too sharply, sending the flow of air to one section of the Air Hawk, which causes uneven filter loading.

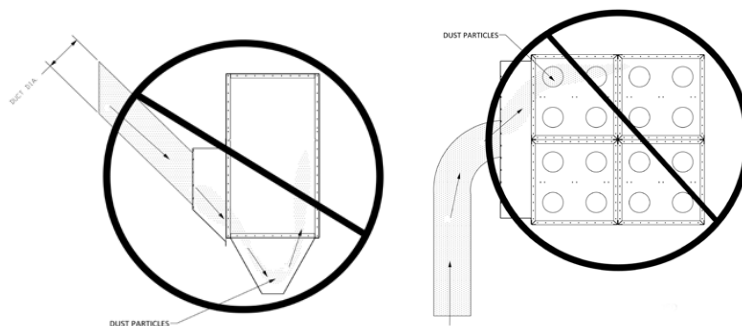

5.6 Remote Mount Fan Discharges

Remote mount fans provided by Diversitech will be ducted to the collector by removing one or multiple upper panels and attaching the duct work to the frame of the Diversitech Air Hawk dust collector.

5.7 Top Mount Fan Discharges

Top mount fans, provided by Diversitech, are field mounted on the top of the Diversitech Air Hawk collector.

6 Utility Connections

6.1 Motor Connections

Diversitech can supply a fan, motor starter, and discharge devices such as rotary air locks. If you choose, you can supply your own fan or other accessories. Please discuss any supply changes with your Diversitech representative. Before ordering your own accessories, ensure that they meet the electrical specifications for your equipment. All accessories and equipment must be installed in accordance with local electrical code and safety regulation standards.

To connect the motor starter, follow these steps:

1) Choose a convenient location to mount the motor starter. Some recommended locations are:

- a. A support leg
- b. A plant wall near the collector

2) Mark any drilling holes by using the motor starter enclosure as a template.

3) Mount the motor starter enclosure.

4) Diversitech recommends J-style current limiting fuses that meet or exceed the full load amperes listed on the motor nameplate by 150%. Please consult the National Electronic Code for further information and follow your local code regulations.

Diversitech fans are intended for continuous duty. It is not recommended to cycle power to the fans more than twice an hour. Cycling power to the fans more than twice per hour results in premature failure of the motor starter, fan motor, fan, and voided warranty claims.

6.2 Timer Control Connections

1) Refer to the General Electrical drawing and confirm the electrical requirements for your equipment and installation location.

2) Mount the timer control close to the Air Hawk to monitor performance. Recommended locations include:

- a. A nearby wall
- b. A nearby stand

Do not mount the timer control on the side panels of the dust collector. The pulse jets vibrate the side walls which can damage electrical connections to the timer control.

6.3 Solenoids Connections

1) Locate the solenoid cover.

2) Loosen the two Philips head screws on the bottom of the housing.

3) Lift the cover straight up to expose the solenoids.

4) There are two wires attached to each solenoid:

- a. One wire for the numbered row of cartridges.
- b. A second wire, called the "common," is attached to all the solenoids. The common is pre-wired by the solenoids manufacturer.

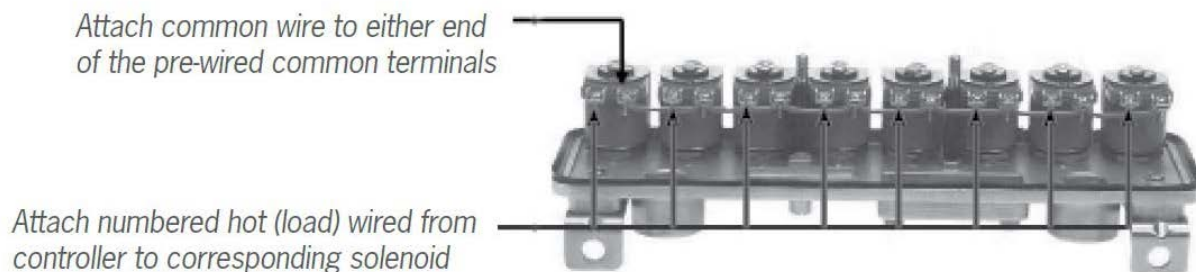

6.4 Collector Timer Control Connections

Your Air Hawk has a control timer or a Magnahelic gauge to monitor the differential pressure inside the collector.

- 1) Locate the control package which contains the assembly hardware.
- 2) Locate the 1/8" NPT pressure taps, located on the top and bottom end panels of the collector, labeled as "Dirty Air / High Pressure" and "Clean Air / Low Pressure."
- 3) Remove the two 1/8" elbow fittings from the control package.
- 4) Attach the elbow fittings to the 1/8" NPT pressure taps.
- 5) Remove the 1/4" black polylines. Each line is labeled to match the 1/8" pressure taps on the collector. The collector timer control uses similar labels.
- 6) Attach the labeled port on the timer control with the matching labeled port on the collector using the black polyline that has the same label.
- 7) If your Air Hawk comes equipped with a Magnahelic gauge, the installation process is the same, but the labels are "High Pressure" and "Low Pressure."

6.5 Compressed Air Connection

The compressed air reservoir located in the header of your Air Hawk requires clean, compressed air in the range of 90-105 psi.

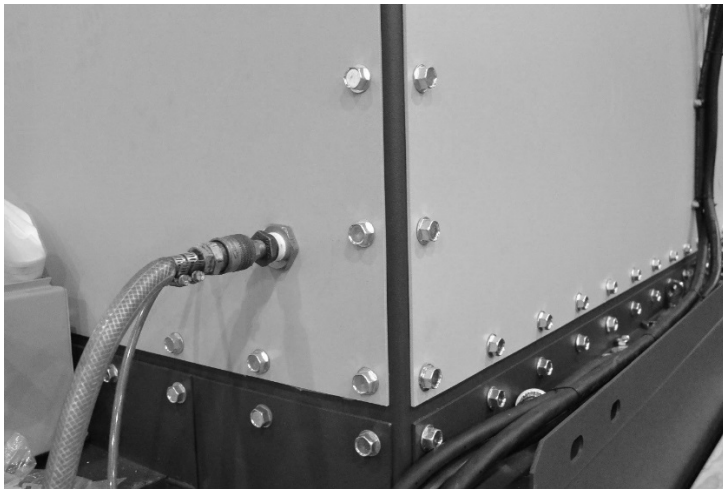

Do not use unclean compressed air lines with your Air Hawk. Oil or water in the compressed air -line causes premature filter failure.

Your compressed air supply should have the following:

- 1) Manual shut-off valve
- 2) Filter or separator
- 3) Air regulator
- 4) Pressure gauge
- 5) Dew point of -40 F
- 6) Air reservoir condensation draining equipment, such as an automatic tank drain

The first four items should be close to the unit to allow operators to monitor system performance. While the Air Hawk is operating, air consumption varies depending on the amount of dust in the air and cleaning cycle set points.

To inspect the compressed air for your Air Hawk:

- 1) Slowly open the shut-valve.
- 2) Pressure gradually builds in the tank. Let it reach the optimum range of 90-105 psi.
- 3) Close the valve.
- 4) Check the following location for air leaks:
 - a. Header
 - b. Valves
 - c. Fittings
 - d. Solenoid valves
- 5) Stop any leaks by tightening relevant clamps and fittings.
- 6) Open the air shut-off valve.

Sprinkler Connections (Optional)

If your purchase includes a sprinkler system, follow these instructions to connect them. If using more than one sprinkler system, ensure the supply pipe is sized correctly to allow for the target flow rate. Check the National Fire Protection Agency (NFPA) guidelines and your local codes and regulations for more information.

- 1) Locate the sprinkler connection coupling(s).

7 Explosion Vents(Optional)

In an industrial setting, many types of dust are combustible. Dust is considered any particle smaller than 420 microns. Combusting dust results in injury, loss of life, and property damage. Special precautions must be taken to ensure a safe work environment when working with combustible dusts. The National Fire Protection Agency (NFPA) provides extensive information and protocols on explosive dust. The following list contains publications recommended by Diversitech that meet NFPA regulations on handling, collecting, and processing combustible dusts:

- NFPA 654 Standard for the Prevention of Fire and Dust Explosions from the Manufacturing, Processing, and Handling of Combustible Particulate Solids
- NFPA 69 Standard on Explosion Prevention Systems
- NFPA 68 Guide for Venting of Deflagrations
- NFPA 664 Standard for the Prevention of Fires and Explosion in Wood Processing and Woodworking Facilities
- NFPA 651 Standard for the Machining and Finishing of Aluminum and the Production and Handling of Aluminum Powders
- NFPA 77 Recommended Practice on Static Electricity

This list is not a comprehensive list of all NFPA publications relevant to your specific application. Each NFPA publication in this list cites additional NFPA publications which must also be referenced if applicable to your situation. Always use the most recent publication.

7.1 Concerning Explosion Vents

The dust collectors provided by Diversitech are only one part of a full dust collection system. The installation of an explosion vent by itself is often insufficient to meet NFPA recommendations, and additional equipment is advised. For example, according to NFPA 654:

“Systems that handle combustible particulate solids shall be designed by and installed under the supervision of qualified engineers who are knowledgeable of these systems and their associated hazards.” Adherence to NFPA standards and recommendations is important to minimize the risks involved with combustible dusts. Diversitech is not involved with the design of your dust collection system and does not guarantee that using an explosion vent satisfies all standards and recommendations of the NFPA.

7.2 General Explosion Vent Guidelines

The following information contains paraphrased content from the reference NFPA publications. The content is a guide on how to work with explosive dusts, but it does not relieve the purchaser or operator of responsibility. It is the purchaser and operator’s responsibility to ensure that the complete dust collection system is designed, installed, and operated in accordance with NFPA standards and recommendations.

- It is important to note that venting does not prevent a deflagration. Venting can, however, minimize the destructive effects of a deflagration.
- Refer to NFPA 654 Standard for design requirements for the complete dust collection system.
- Systems that handle combustible particulate solids shall be designed by and installed under the supervision of qualified engineers who are knowledgeable of these systems and their associated hazards.
- Several methods are available for the design of explosion protection for equipment. See NFPA 68, Section 3.1.1
- Where an explosion hazard exists, isolation devices shall be provided to prevent deflagration propagation from air-material separators upstream to the work areas. Isolation devices include, but are not limited to, those listed in NFPA 654 section 3.1.3.1 §1 through §5.

- The specific conditions of the hazard and the objectives of protection are the basis for the choice of the most effective and reliable means for explosion control. Venting of explosions only minimizes the damage that results from combustion.
- Substances other than oxygen can act as oxidants. NFPA 68 vent calculations apply only where the oxygen in the air is the only oxidant. If chemical oxidants are present as either solid particulate or gas, then explosion suppression and isolation equipment are required as recommended in NFPA 69.
- Situations can occur in which it is not possible to provide calculated deflagration venting as described in NFPA 68. Such situations do not justify the exclusion of all venting. Provide the maximum practical amount of venting, since some venting should reduce the damage potential. Also, consider other protection and prevention methods.
- It is not possible to successfully vent a detonation.

7.3 Explosive Dusts

Dusts are solid particles 420 microns or smaller and capable of passing through a U.S. #40 sieve. Particle size distribution characterizes how fine the dust is. The maximum pressure and K_{st} of a dust increase as the size of the particle decreases.

Combustion properties of a dust are a result of its chemical and physical characteristics. Published dust flammability data is available for many dust particles. However, inadequate vent design can result if the process dust is not the same as the dust in the published particle data. When using published particle data, ensure that the following characteristics of the particles being processed are the same:

- Size
- Shape
- Chemical properties

Please see NFPA 68 Section B-5 for more information.

7.4 Explosion Vent Guidelines

Please use the following guidelines when operating your explosion vent system.

- The goal of venting is to limit the pressure inside an enclosed space during the event of combustion through the controlled release of expanding gasses.
- If an explosion hazard exists, then dust collectors must be installed outside of the building. Some exceptions exist, such as isolation and suppression systems listed in NFPA 654 Section 3.1.1.
- Always direct a venting path outside to a safe location. Failure to do so may result in injury, death, and property damage. Please see NFPA 68 3.2.3 for further information.
- The venting path does not enter into personnel traffic areas.
- The vent path should not allow vented material to enter air intakes.
- Do not use shields that deflect the pressure exiting a vent during a combustion event. Do not orient the vent such that a nearby object, such as a wall or machine, acts as a shield to deflect pressure waves. If the vent exhausts gasses into a congested area, the pressure increases, and potentially cause the ignition of unburned gasses or dust outside of the system.
- The space on both sides of the vent must be clear so the vent can open and close without restriction.
- Vents must operate properly for the vent system to function. Check vents for blockage, such as snow, paint, corrosion, or buildups inside the system. Do not seal a vent closed by painting over its surface.
- Vent closures should be maintained in accordance with Chapter 10 of NFPA 68 and the manufacturers' recommendations. The occupant of the property in which the deflagration vent closures are located is responsible for inspecting and maintaining such devices.
- Maintain all vents by the regulations outlined in NFPA 68, Chapter 10, and the manufacturer's guidelines. In some cases, replacing a vent is necessary to ensure proper operation.
- Always select materials for your vents that are corrosive resistant for your target application.
- Maintain all signs for explosion vents. Replacement signs are available from Diversitech if a sign has become illegible.

7.5 Location of Vents and Vented Equipment

7.6 Ignition Sources

- Some types of ignition sources include electric (arcs, sparks, and electrostatic discharges), mechanical (friction, grinding, and impact), hot surfaces (overheated bearings), and flames (welding torches, and so forth).

7.7 Vent Discharge Ducts

- If a dust collector is located inside a building it should be located near an external wall and the exhaust from the vent ducted to the outside.
- The addition of a vent discharge duct can substantially increase the pressure developed in a vented enclosure. (See NFPA 68 Section 5.4.) Sizing of the vent should take this into consideration.
- Ducts that are used to direct vented gases from the vent to the outside of a building should be of noncombustible construction and should be strong enough to withstand the expected Pred. Ducts should be as short as possible and should not have any bends. (See NFPA 68 Section 5.2.9.)
- The duct length must be calculated per NFPA Guidelines if it extends beyond the Hydraulic Diameter of the Vent and must not interfere with the operation of the vent.
- Bird screens or weather hoods must be low restriction and their affect should be taken into consideration when sizing the vent area.

7.8 Vent Inspection and Maintenance

- Diversitech offers rupture diaphragm style explosion vents on their dust collectors. Explosion vents should be inspected every three months. The inspection and maintenance points are outlined below.
- Remove obstructions such as snow, ice, dust inside and out if present, with equipment not running.
- Replace safety decals if missing or illegible.
- Tighten and replace bolts if missing.
- Area around vent is free and clear of obstructions.
- Check that flammable materials are not stored near the vent.
- Rupture diaphragms have no moving parts and should be inspected for tears rips or cracks, replace if present.

8 Filter Installation and Replacement

Multiple types of replacement filters are available. Contact Diversitech for assistance in acquiring the best replacement filters for your needs at 800-361-3733.

Follow these steps to replace the filter:

- 1) Disconnect
 1. Disconnect electrical power to the fan and control box. Disconnect compressed air service from the compressed air header. Bleed all air from the air header. Perform an OSHA approved lock-out/tag-out procedure on these and any other energy sources.
 2. Open the access doors at the front of the unit, swinging them out of the way.
 3. Unlatch the clamp bars as shown in below. With your left hand, rotate the right clamp bar up and pull it toward you, until its locking tab clears the rectangular cut-out on the left clamp bar. With your right hand, rotate the left clamp bar up and push it away from you until its locking tab clears the rectangular cut-out on the right clamp bar. Rotate both clamp bars down until they are vertical and clear of the cartridge extraction path. Remove all dirty filter cartridges by sliding them off the clamp bar channels. Clean the surface of the tube sheet in the areas where the filter gasket forms a seal.
 4. Remove a new cartridge from the shipping carton, taking care not to cut or otherwise damage the filter media. Make sure the clamp bar handles are fully opened and will not interfere with the cartridge during installation. Grasp the new cartridge by the top metal pan and set it onto the clamp bar channels. Holding the cartridge level, slide it forward, pushing on the cartridge pan, do not push the media, taking care not to drag the gasket along the tube sheet. Push the cartridge in just far enough to leave room for the next cartridge to rest on the clamp bar channels. Repeat steps 4 and 5 until the row is full.
 5. To seal the new cartridges, repeat the instructions in Step 3 in reverse order. With your left hand, rotate the left clamp bar counter clockwise or up to between 80° and 90°. While pushing the left clamp bar away from you, rotate the right clamp bar clockwise or up, with your right hand. Insert the locking tab on the left clamp bar when it lines up with the rectangular cut-out on the right

clamp bar. Release the left clamp bar. With both hands rotate the right clamp bar clockwise or up and pull it toward you, until the locking tab inserts into the rectangular cut-out on the left clamp bar. The clamp bars must be bent slightly if the locking tabs do not stay inserted in the rectangular cut-outs.

6. Repeat steps 3 through 6 until all the rows of cartridges are changed.



8.1 Pre-coating of Filters (optional)

Pre-coating filters extends the filter life. Pre-coat when the dust concentration is low and or the dust particles are less than 0.5 microns. Maximum filter efficiency requires a layer of dust to cover the filter media, which in low concentration or small particle applications, can require weeks to achieve. Pre-coating brings the filter to maximum efficiency in a few hours. This is especially important for applications where the dust recirculates through the safety filters, contains hydrocarbons, or if the dust is toxic.

8.2 Pre-Coating Procedure (Optional)

To pre-coat your filters, follow these steps:

- 1) Verify that all filter cartridges are installed properly.
- 2) Install a clean, empty discharge container under the unit.
- 3) Remove safety filters, if any are present.
- 4) Disable the dust collector unit by shutting off the compressed air then bleeding the compressed air reservoir, or by turning off the power to the timer control.
- 5) Using table X, weigh out the appropriate amount of pre-coat dust.
- 6) Start the dust collector and add pre-coat dust into a suction hood in the duct system.
 - a. If the suction hoods are not accessible, remove the container under the discharge and add pre-coat through the hopper discharge.
- 7) The fan outlet emits dust. This is normal.
- 8) When the dust stops exhausting from the fan outlet, the pre-coat process is complete.
- 9) When all the dust has been applied, collect the dust from the discharge container and repeat the above procedure.
- 10) Log the reading on the Magnehelic gauge.

- 11) Measure the airflow using a pilot tube or similar device.
- 12) Set the fan damper to correspond to the system designed airflow.
- 13) Remove any pre-coat dust remaining in the ducting outlet and discard according to local codes and regulations.
- 14) Re-enable the collector by either opening the compressed air line or turning on the power to the timer control (see step 4). *Do not pulse on continuous.*
- 15) The system is now ready for use.

9 Operation of Your Equipment

Diversitech has prepared this proprietary user's manual for the exclusive use of its customers. The recommendations contained herein are based on proven techniques and on test data believed to be reliable. It is intended that personnel having specialized training in accordance with currently accepted practice and normal operating conditions use this manual. Variations in environment, changes in operating procedures or extrapolation of data, may cause unsatisfactory results. Since Diversitech has no control over the conditions of service, it expressly disclaims responsibility for the results obtained or for any consequential or incidental damages of any kind incurred.

The Diversitech Air Hawk dust collector described in this manual is designed for the collection of welding fumes and/or the capture of airborne particles generated from mixing, sanding, grinding and cutting operations involving wood, metal, fiberglass, plastics, advanced composites or similar materials.

Precoat Data		
Model	Amount (lbs)	
	Perlite	Limestone
GS2	4	18
GS4	8	36
GS6	12	54
GS8	16	72
GS10	20	90
GS12	24	108
GS16	32	144
GS20	40	180
GS24	48	216
GS36	72	324
GS48	96	432

10 System Operation

The Diversitech Air Hawk operates as follows:

- 1) Dust enters the inlet.
- 2) A baffle forces large or heavy dust particles to drop into the hopper.
- 3) The clean air passes through the filter media from the outside to the inside of the filter cartridge and exits through the open top of each filter cartridge.
- 4) The air then flows from the filters into the clean-air plenum, where it enters the fan inlet and is exhausted. The dust is captured on the outside surface of the filter media.
- 5) Clean air is exhausted.

For the filters to work properly, they must be covered in a "dust cake", which results in a drop in air flow. The filters must also be cleaned periodically, so a balance needs to be met between a dust cake, cleaning cycles, and reduced air flow. The timer controller or Magnehelic gauge maintains this balance by pulsing the filter material, which maintains an optimal dust cake. Pre-coating the filters with a Diversitech-provided dust designed for pre-coating applications is strongly recommended for optimal efficiency and lifetime of your filters. Different filter materials are available for different applications. If you have questions about which filter material to use, contact Diversitech or your local Diversitech representative.

Always use caution when working near the Air Hawk. Always wear appropriate safety gear, including eye and ear protection. The noise level of the cleaning cycle can cause hearing damage. The diaphragm valve may discharge projectiles. Do not operate the Air Hawk with the access doors open.

10.1 Cleaning the Filters

The filters go through a cleaning cycle while the machine is operating. There is no need to shut the machine down to clean the filters. Filter cleaning involves reversing the flow of air through the material in pulses, which dislodges accumulated dust. The filter set being cleaned is cycled so that the remaining filters are available to clean the air in the environment.

10.2 Cleaning the Header (Compressed Air Pressure Reservoir)

To clean the header, supply it with clean, dry, compressed air in the optimal range of 90-105 psi.

10.3 Solenoid/Diaphragm Valves

There is one solenoid per diaphragm valve.



Solenoid-operated valves on the collector operate typically one diaphragm valve each. Diaphragm valves on the air reservoir operates one pulsejet blowpipe each. The automatic timer control energizes the solenoid, which causes the valve to decrease air pressure through the exhaust port. This release of pressure also releases pressure from the outer chamber or back side of the diaphragm valve. The resulting difference in air between the outer chamber and the compressed air reservoir allows the diaphragm valve to open. This allows the air in the header to be released into the pulsejet blowpipes. The size of the diaphragm valves is 1" or 1-1/2", depending on the size of the collector.

10.4 System Overview

Display/Keypad

There are four round buttons on the front panel for controlling the device and turning on the display as shown in the following figure.



Press SET to open and close the programming menu and activate the manual solenoid test by selecting function F06.

Press + and - to select a function, increase/decrease values, view the total hour counter (+) and the maintenance counter (-).

Press OK to confirm data and reset the alarms.

Menu Diagram

How to access programming:

- Press SET, the letter F flashes. (see figure).



- Press + and - to select the required function.
- Press OK to confirm.
- Increase or decrease the value of the parameter.
- Press OK to confirm and exit.
- Press SET again to exit programming mode.

List of Functions

F01:

Configuring the operation mode.

Possible values: 0 - Manual (dP excluded)

1 - Automatic (Default) (dP included)

2 - Automatic with forced cycle (dP included)

3 - Proportional (dP included)

F02:

Solenoid activation time.

Possible values: 0.05 seconds - 5.00 seconds step 0.01 seconds.

Default = 0.20 seconds.

F03:

Washing pause time between solenoid valves.

Possible values: 001 seconds - 999 seconds step 1 seconds.

Default = 20 seconds.

F04:

Number of connected outputs.

Possible values: 01 - 16 step 1.

Default = 001.

F05:

Output voltage setting, must agree with jumpers.

Possible values: 24 Vdc, 24 Vac, 115 Vac, 230 Vac.

Default = 115 Vac.

F06:

Manual output activation.

Possible values: 1 - number of outputs set in F04.

Press SET to activate the set output.

F07:

Zero dP threshold.

Possible values: 0.00 inch WC - 20 inch WC step 0.01.

Default = 0.00 inch WC.

F08:

Cleaning cycle start threshold high dP set point.

Possible values: 0.00 inch WC - 20 inch WC step 0.01.

Default = 3.2 inch WC.

F09:

Cleaning cycle stop threshold low dP set point.

Possible values: 0.00 inch WC - 20 inch WC step 0.01.

Default = 1.6 inch WC.

F10:

Max dP Alarm Threshold (Filter Clogging if detected for longer than 20 seconds)

Possible values: 0.00 inch WC - 20 inch WC step 0.01.

Default = 12 inch WC.

F11:

Fan on recognition mode for after cycle cleaning.

Possible values: 0 from contact - 1 from dP.

Default = 1 from dP.

F12:

dP threshold for fan on recognition if F11=1.

Possible values: 0.00 inch WC - 20 inch WC step 0.01.

Default = 0.4 inch WC.

F13:

Number of post cleaning cycles after stopping the fan.

Possible values: 01 - 99 step 1.

Default = 00.

F14:

Post cleaning mode pause time between solenoid valves (fan off).

Possible values: 001 seconds - 999 seconds step 1 seconds.

Default = 10 seconds.

F15:

Maintenance frequency expressed in tens of hours (e.g.: 1=10h, 10=100h).

Possible values: 001 - 999 step 1.

Default = 100 (=1000h).

F16:

Maintenance deadline alarm enable.

Possible values: 0 (disabled) - 1 (enabled).

Default = 0 (disabled).

F17:

Maintenance hour counter reset.

Possible values: 0 (disabled) - 1 (reset).

Default = 0 (disabled).

Note: The maintenance hour counter will be reset and the F17 parameter will be set back to 0 by setting F17 to 1.

F18:

Precoating function enabling.

Possible values: 0 (disabled) - 1 (enabled).

Default = 0 (disabled).

F19:

dP threshold for precoating function.

Possible values: 0.00 inch WC - 20 inch WC step 0.01.

Default = 8 inch WC.

F20:

Enabling Minimum dP Alarm function if detected for longer than 60 seconds.

Possible values: 0 (disabled) - 1 (enabled).

Default = 0 (disabled).

F21:

Min dP Alarm Threshold (Broken Sleeve/Cartridge)

Possible values: 0.00 inch WC - 20 inch WC step 0.01.

Default = 0.8 inch WC.

F22:

Selection of minutes or hours for Forced Cleaning Cycle. (Only if the operating mode F01 = 2)

Default = Minutes (0 =minutes, 1 =hours).

F23:

Setting time interval for Forced Cleaning Cycle in relation to the choice of F22.

Setting values: 1 - 999 step 1.

Default = 240 (240 minutes).

F24:

Exclusion of valve in short circuit.

The default setting is 0, the valve in short circuit is tested at each cycle.

If set to 1, when a valve is in short circuit is excluded from the cycle and is not rechecked.

Alarms

The unit runs a number of checks during the start-up cycle and during normal operation. The possible alarms and respective solutions are shown in the following table.

ALARMS TABLE

Alarms

The unit runs a number of checks during the start-up cycle and during normal operation. The possible alarms and respective solutions are shown in the following table.

ALARMS TABLE

Alarm number	Description	Action
E01	F05 set to 24Vdc – AC jumper detected	- For 24Vdc, switch the device off and move the AC/DC jumpers to DC. Jumper table p. 12. - For 24Vac, press OK, then press SET, set the function F05 using "+" and "-", select A24 and press OK to confirm.
E02	F05 set to 24Vac – DC jumper detected	- For 24Vac, switch the device off and move the AC/DC jumpers to AC. Jumper table p. 12. - For 24Vdc, press OK, then press SET, set the function F05 using "+" and "-", select d24 and press OK to confirm.
E03	F05 set to 24Vac or dc. Voltage out of range detected	- To use 24V valves, switch the device off and move the output voltage selection jumper to 24V. Jumper table p. 12. - If the jumper is in the correct position, press OK, then SET, select the F05 function with "+" and "-", set 115 or 230 (as jumper) and press OK.
E04	F05 set to 115V. Voltage out of range detected	- To use 115V valves, switch the device off and move the output voltage selection jumper to 115V. Jumper table p. 12. - If the jumper is in the correct position, press OK, then SET, select the F05 function with "+" and "-", set 115 or 230 (as jumper) and press OK.
E05	F05 set to 230V. Voltage out of range detected	- To use 230V valves, switch the device off and move the output voltage selection jumper to 230V. - If the jumper is in the correct position, press OK, then SET, select the F05 function with "+" and "-", set a24, d24 or 115 (as jumper) and press OK.
E06	Solenoid valve current lower than minimum threshold or disconnected solenoid valve	Check correct connection of the solenoid valve and respective data. The alarm is self-reset.
E07	Solenoid valve current higher than maximum threshold	Check correct connection of the solenoid valve and respective data. The alarm is self-reset.
E08	Output short circuit. Alarm The signaling of the code E08 alternates with the indication of the interested output is shown as Uxx where xx is the number of the output and the value of dP.	Switch the device off and back on after having checked the solenoid valve system.
E09	dP maximum pressure exceeded (F10) Detected for longer than 20 seconds.	Check state of filtering elements.
E10	dP sensor hardware offset out of range.	The self-calibration of the dP sensor has determined that a value is out of range. Disconnect the air tubes and repeat the function. Take the device to be serviced if the alarm occurs again.

E11	Maintenance deadline reached	Carry out maintenance.
E12	dP sensor full-scale value reached Immediate reporting without any delay.	Check state of filtering elements. IMPORTANT: Running in this condition may damage the device.
E13	Minimum dP alarm value ranging from F12 to F21 (warning: the alarm is generated with a fixed delay of 60 seconds).	Check the status of the filtering elements.
E14	Indicates that a valve in short circuit has been excluded from the cycle. The signaling of the code E14 alternates with the indication of the interested output is shown as Uxx where xx is the number of the output and the value of dP. An output is considered a short circuit if not responding for 3 following activations. An activation without error resets the counting.	Switch the device off and back on after having checked the solenoid valve system.]

Description Of Operation

The installed SW version and the symbol ---, meaning that coherence between settings stored in E2Prom and the set jumpers is being checked, will appear on the display when the economiser is powered up. A corresponding error code will appear in case of discrepancies between settings (see Alarms Table). Only editing functions will be allowed on the unit. The operator may switch off the unit and configure the jumpers correctly.

Symbol 0_0 will appear on the display if the test is entirely successful. The following pages will then appear:

n automatic mode (F01=1):

- o dP value alternating with OFF if the enabling contact (14-15) is open
- o dP value alternating with -0- if the enabling contact (14-15) is closed and the fan is off
- o dP value only if the fan is enabled and active.

n manual mode (F01=0):

- o OFF if the enabling contact is open (14-15)
- o -0- if the enabling contact (14-15) is closed and the fan is off

Manual Operating Mode F01=0

The economiser will work as a programmable cycle sequencer in manual mode. The connected outputs will be activated at the programmable frequencies. Manual mode can be activated by accessing the configuration menu and setting F01 to 0. F02 and F03 will set the activation time and the pause time, respectively.

Automatic Operating Mode F01=1

By selecting automatic mode (F01=1), the economiser will work autonomously can carry out the pneumatic washing cycle only when needed. The device will start the washing cycle if the obstruction is higher than Threshold_dP_Start (F08). Washing is suspended when obstruction drops under Threshold_dP_Stop (F09) level until it reaches a value higher than the Threshold_dP_Start threshold once again. When washing is active, the economiser respects the times set in F02 (operating time) and F03 (pause time).

Automatic Mode With Forced Cycle F01 = 2

Identical to the automatic mode, except for the fact that it is possible to obtain a cleaning cycle with the activation of the solenoid valves connected without reaching the Threshold_dP_Start (F08). The forced cleaning interval may range from 1 to 999 h and can be selected through function F22 and F23.

Proportional Mode F01 = 3

With the proportional mode, the economiser will work in full autonomy, initially setting the dP_Start threshold (F08), activation time (F02) and pause time (F03).

When the Start Cleaning threshold is exceeded, the solenoid valves are automatically activated in sequence. If the dP threshold drops below 15% at the end of an entire cycle of pulses of the connected solenoid valves, the washing is suspended until pressure returns to a value above the Start Cleaning dP value. If the dP value does not drop below 15% of the Start Cleaning threshold, the frequency of the cycle time is automatically reduced in proportion with each entire cycle of pulses of the connected solenoid valves, until a minimum cycle time between solenoid valves reaches 10 seconds. The minimum threshold

of 10 seconds has been chosen so as not to hamper the dispensing of air by the compressor connected to the filter.

Cleaning Function With Fan Off (PCC)

This function allows to carry out one or more cleaning cycles (the number of cycles is defined by F13) when the fan is off. The on or off state of the fan may be determined by the state of the contacts 12- 13 (contacts open = fan off) if F11=0, or may be determined automatically (with F11=1) when the dP pressure drops under the threshold defined in F12. The pulse time of the valves will always be that defined in F02, while the pause time in this case is defined in F14.

The display alternately shows the number of the valve activated and the word PCC.

Number Of Output Selection

The number of outputs (solenoid valves) on which the economiser will run the cleaning cycle can be selected. Cleaning will be carried out in order from the first to the last solenoid valve. The valves can be adjusted by the F04 function.

Precoating Function (F18=1)

This function is used to carry out precoating. Precoating is a filtering element treatment carried out with precoating powder. Washing and manual output activation is suspended during precoating until the precoating thresholds defined in F19 is reached. The dP value and the message PC (precoating) will appear alternatively on the display.

dP Zero Calibration (F07)

This function is used to reset dP reading with the fan off. Increase or decrease the value shown by pressing "+" and "-" as required. This value will be subtracted from the value read by the dP sensor.

dP Sensor Self-Calibration

This function allows to reset dP reading with the fan off automatically. Hold "SET" and "OK" pressed at the same time with the device off. The message "CAL" will appear after the start-up test. Release the buttons. The unit will go back to normal state after a few instants.

Automatic calibration is complete.

Fuse

A fuse which can be reset in case of need is located near the power terminal board. Use a delayed fuse 5x20mm.

Connection Diagram

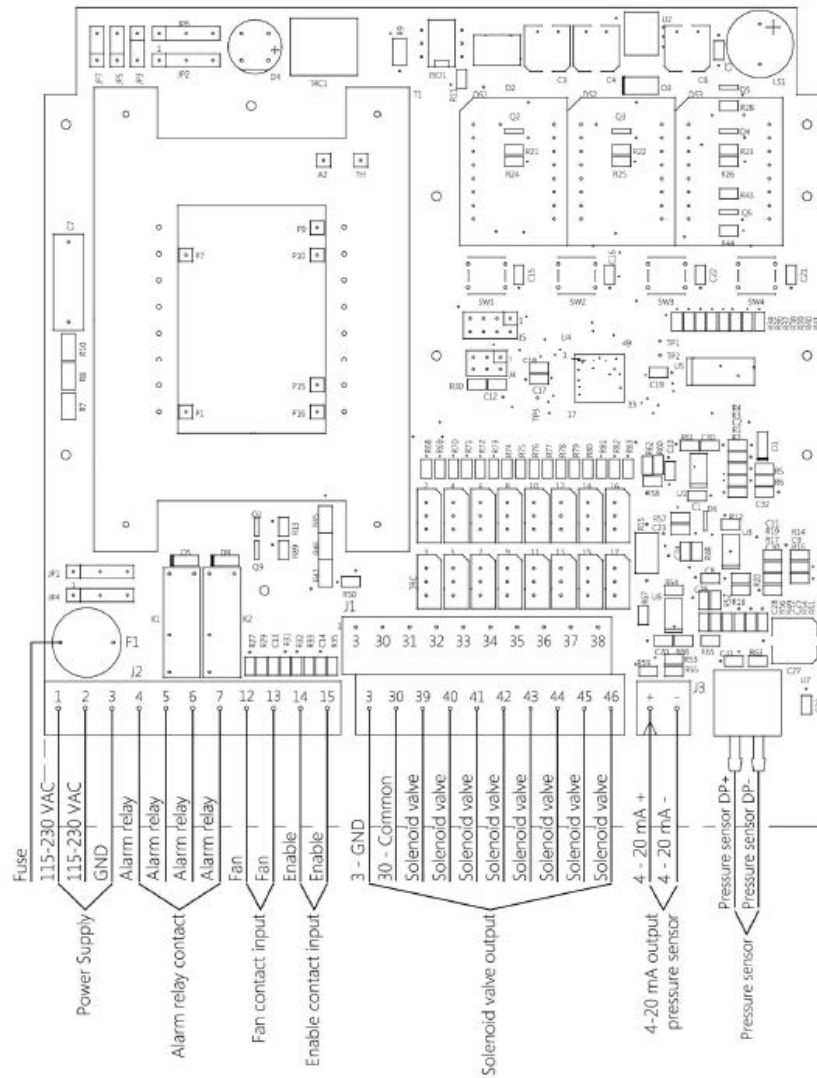

Contacts And Relay Terminal Block J2

Enable contact input consensus 14.15 terminals.

Is used to activate the control unit remotely, it can be turned on and off remotely.

The unit is supplied with a jumper on the two terminals 14:15, without it will not turn on.

Fan contact 12.13 input terminals.

Indicated by the control unit that the plant has been started and is in operation.

The unit is supplied with a jumper on two 12:13 terminals to simulate the state of the plant, as if the fan was turned on.

Alarm Relay K1 4.5 terminals.

The relay is normally closed, opens in case of alarms, and opens to the control unit off in the absence of power.

The alarms that open the relays are:

Max dP has been reached.

Min dP has been reached.

Problem with solenoid valves E06-E08.

Maintenance interval has been reached.
 If one of these occurs, the relay is activated.
 Alarm Relay K2 6.7 terminals.

The relay is normally closed, opens in case of alarm, and opens to the control unit off in the absence of power.

The alarm that open the relays is:
 Max dP has been reached.

Terminals table

Terminal n.	Description	Terminal n.	Description
1	Power 115 – 230 Vac	35	Solenoid 5 output
2	Power 115 – 230 Vac	36	Solenoid 6 output
3	Earth (GND)	37	Solenoid 7 output
4	Relay contact	38	Solenoid 8 output
5	Relay contact	39	Solenoid 9 output
6	Relay contact	40	Solenoid 10 output
7	Relay contact	41	Solenoid 11 output
12	Fan input	42	Solenoid 12 output
13	Fan input	43	Solenoid 13 output
14	Enable input	44	Solenoid 14 output
15	Enable input	45	Solenoid 15 output
30	Solenoid valve common	46	Solenoid 16 output
31	Solenoid 1 output	11	"+" 4-20mA dP output
32	Solenoid 2 output	10	"-" 4-20mA dP output
33	Solenoid 3 output		
34	Solenoid 4 output		

Fuse table

Voltage	Value
230 V	1 A
115 V	1 A
24 Vdc / ac	3 A

Jumper configuration – Power Output

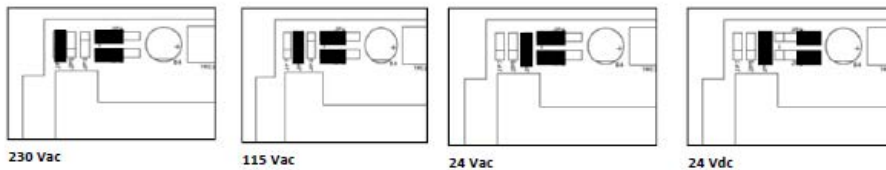

Jumper configuration - Power Input

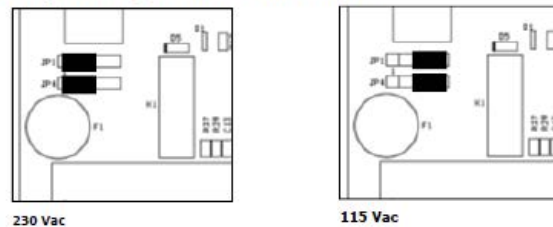

Installation - Casing dimensions 12 / 16 Outputs

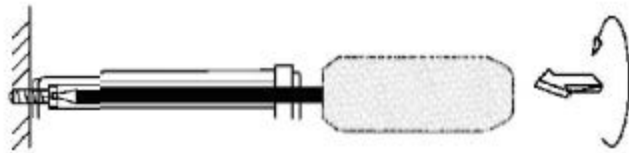
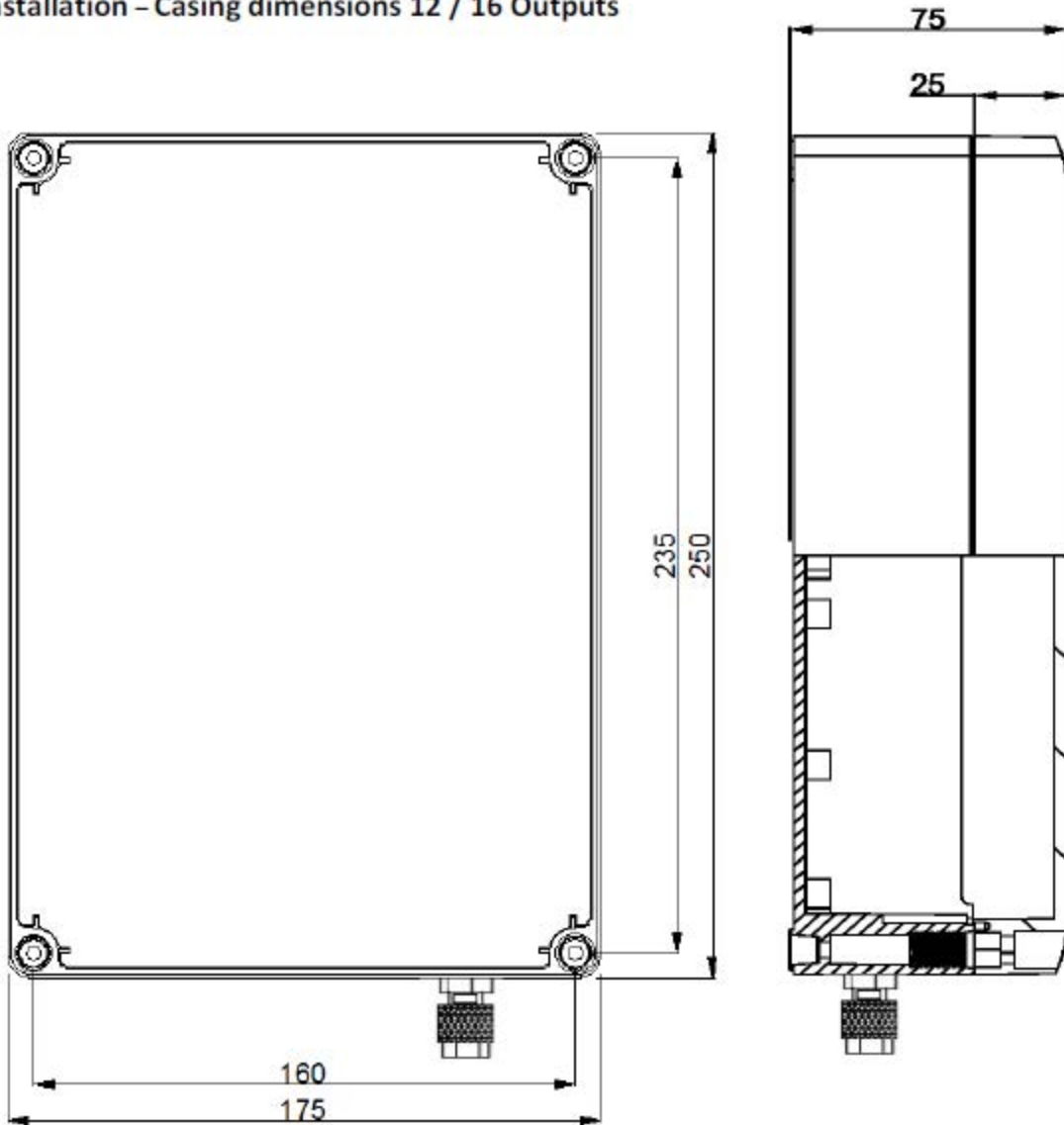

Installation - Casing dimensions 4 / 8 Outputs

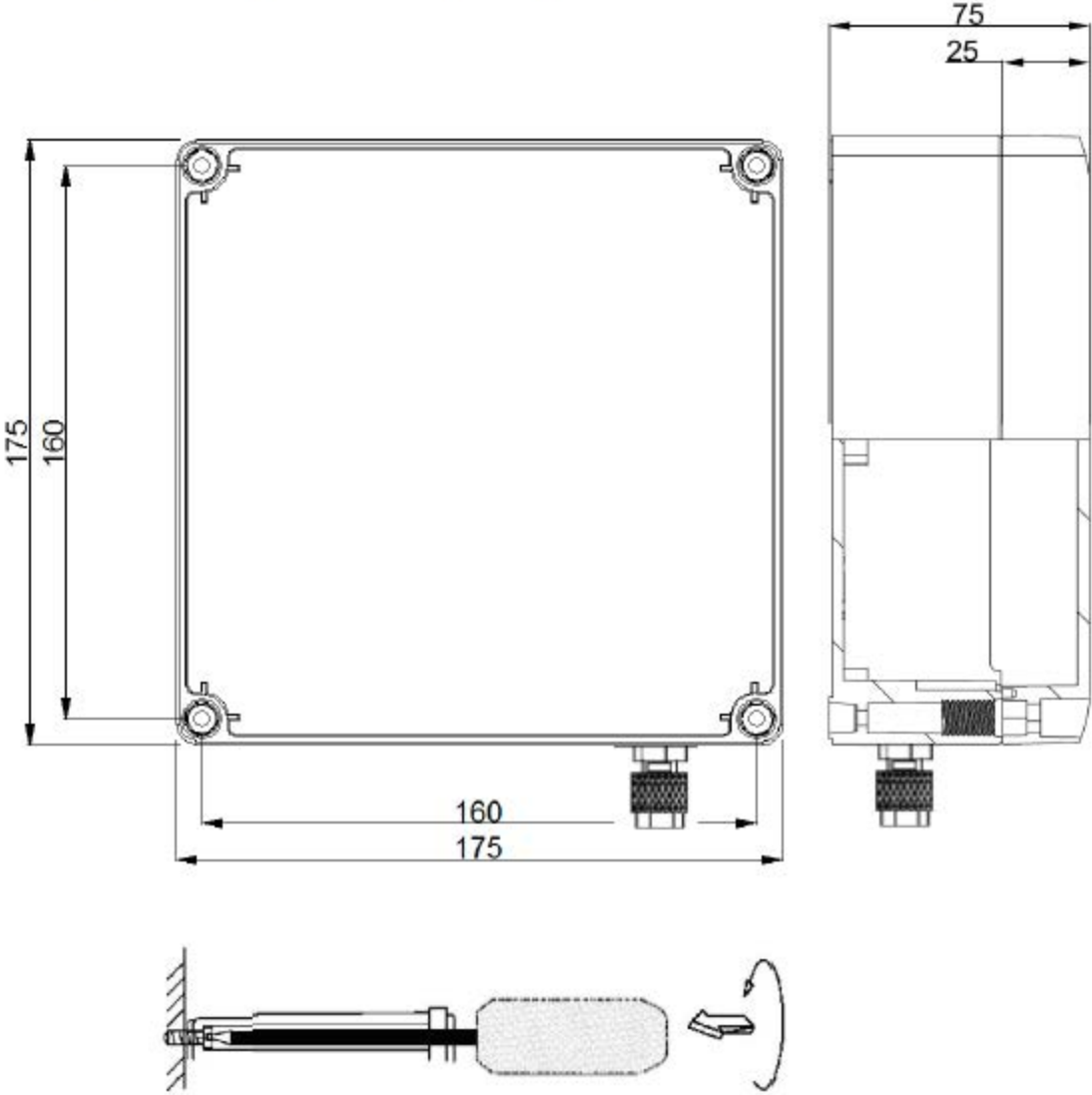

Maintenance

The only parts which may be replaced are fuses.
All other operations must be carried out by the manufacturer.

Scrapping

Dispose of properly after use. Dispose of the product according to laws in force for electronic equipment.



This device is for use in a dust collection system and is therefore part of a fixed installation.

Default Settings

The default settings are:

Function number	Description	Set value
F01	Automatic setting using dP (1) or manual (0)	1
F02	Solenoid valve activation time	0.20 sec
F03	Washing pause time between solenoid valves in normal cycle	20 sec
F04	Number of outputs	1
F05	Output voltage: 24 Vdc, 24 Vac, 115 Vac, 230 Vac.	115 Vac
F06	Manual solenoid valve activation	1
F07	Zero dP threshold	0 inch WC
F08	Cycle start dP threshold	3.2 inch WC
F09	Cycle stop dP threshold	1.6 inch WC
F10	Max. dP level	12 inch WC
F11	Fan mode: 0 from contact , 1 from dP	1
F12	Fan dP threshold (if F11 = 1). If < fan off	0.4 inch WC
F13	Number of cycles after fan stop	1
F14	Pause time between solenoid valves in cycle with fan off	10 sec
F15	Maintenance frequency in 10h (1=10h, 100=1000h)	100
F16	Maintenance deadline alarm on (1) or off (0)	0
F17	Maintenance hour counter reset: set 1 and confirm to reset the maintenance hour counter	0
F18	Precoating on (1) or off (0)	0
F19	Precoating dP threshold (if F18 = 1).	8 inch WC
F20	Enabling Minimum dP Alarm function.	0
F21	Min dP Alarm Threshold (Broken Sleeve/Cartridge)	0.8 inch WC
F22	Cleaning Cycle Forced (only available in operating mode F01 = 2) Set if it handled in minutes or if in hours.	0
F23	Setting the interval time in relation to the choice of F22	240
F24	Exclusion of valve in short circuit.	0

Problem Solution (FAQ)

FAULT	POSSIBLE CAUSE	SOLUTION
The display does not light up.	Burnt fuse.	Check the protection fuse on the power voltage. Check that the power voltage is present and compliant with that required for the device (terminals 1 and 3).
The outputs are not activated.	Incorrect output voltage. Wiring to solenoid valves.	Check that the unit and solenoid valve output voltage agree. Check wiring between economiser and solenoid valves.
The differential pressure reading is not correct.	Obstructed pneumatic connections. Damaged pipes.	Check that the differential pressure is 0.00 inch WC with the pipes disconnected. In this case, check that the connection pipes between device and filter are not obstructed or damaged.
The cleaning cycle is not carried out.	The set cycle start threshold (F08) is too high and therefore the cycle is not activated.	Adjust the start-up pressure threshold or set the economiser to MANUAL mode (F01=0).
Do alarm messages appear?		Check the alarm code with the table.
Do the alarms fail to activate signalling devices?	System wiring errors. No power to alarm devices.	The alarm devices must be powered by voltage external to the economiser. Activating to open the respective relay.
Does post-cleaning start during normal cleaning?	Fan threshold (F12) set too high.	Change the post-cleaning start-up threshold (F12) by lowering it.
Does post-cleaning fail to start when the normal cleaning cycle ends?	Fan threshold (F12) set too low.	Check that the measured pressure is lower than the post-cleaning activation pressure when the fan is off.
Does the economiser occasionally reset?	Check the there is no filtered pulse load on the power line (spot welding machines, welding machines, plasma cutters etc.).	Install a filter on the power line of the economiser, if needed.
The value of 0.0 inch WC does not appear on the display when the fan is off.	dP zero calibration (F07) is not correct.	Calibrate the dP zero by appropriately setting the parameter F07 or running the self-calibration function explained on page 10.

10.5 Startup Procedure

- 1) Begin with a system check.
 - a. Check the status of the fan, discharge devices, ductwork, electrical wiring, and compressed air connections.
 - b. Ensure that the filters are in the clamped-down position.
 - c. Check that the collector doors are closed, latched, and the slide gate is in the open position.
- 2) Supply compressed air and electrical power to the collector.
- 3) Check the fan for the direction of rotation arrows.
- 4) Turn on the collector fan and hopper devices. The goal is to
- 5) Visually inspect the fan and ensure it rotates in the direction indicated by the wheel rotation arrows on the fan.
- 6) If the filters are not pre-coated, the amount of excessive air flow may cause premature filter failure. Pre-coat your filters to avoid this problem. Always inspect fans regularly to ensure they are running in the correct direction and do not vibrate excessively or cause any unusual noises.
- 7) Verify that the airlocks are operating and the slide gates are open.

10.6 Shutdown Procedure

- 1) Stop the operation that generates dust.
- 2) The fan, dust removal device and cleaning mechanisms must continue to operate for at least 20 minutes after the process or dust generating operation are stopped to purge any moisture that remains in the collector.
- 3) Shut off the fan.
- 4) Follow all established lock-out/tag-out procedures.
- 5) To replace the filters, continue pulsing the collector for an additional 20 minutes after the fan shut down, so they are lighter and more convenient to move. If the filters are not to be replaced, do not pulse the unit after the fan is turned off.
- 6) Close the compressed air line valve.
- 7) Follow all established lock-out/tag-out procedures.
- 8) Turn off the controller, discharge devices, and all other electrical equipment.
- 9) Follow all established lock-out/tag-out procedures.
- 10) The collector is now ready for filter replacement, maintenance, or storage.
- 11) If the Air Hawk is stored outside or gathers condensation for any reason, install a heater to allow warm air to pass through the collector while it is shutdown.

10.7 Recommended Timer Settings

If your Air Hawk is equipped with a timer, please use these recommended settings as a starting point:

On-Time Pulse Duration: 150 milliseconds

Off-Time Pulse Duration: 15 seconds

- Pulse Duration (on time) 150 milliseconds This is Diversitech's recommended setting.
- Pulse Frequency (off time) 15 seconds Increasing this value will decrease compressed air consumption. Decreasing this value will increase compressed air consumption. You would decrease this value if your application involves high dust loads and dust that does not easily release from the cartridge. On applications with light dust loads this value can be increased to conserve compressed air.
- High DP Set Point 2 in wg Initiates differential pressure cleaning.
- Low DP Set Point 1.5 in wg Stops differential pressure cleaning.
- High Alarm 6 in wg This value will protect the cartridges from damage due to high differential pressures.

If your system uses differential pressure cleaning, then adjusting these settings is only required for very aggressive applications. Please consult with your Diversitech representative if you feel that different settings are required.

If your system is set to clean continuously, then optimizing these settings is encouraged results in longer filter life. Please follow these steps to optimize your timer settings:

- 1) Set the timer to the recommended settings.
- 2) Log the pressure for 4 weeks.
- 3) If the pressure is below 2 in w.g., increase the pulse frequency by 2 seconds or reduce the pulse duration by 10 milliseconds.
- 4) Repeat steps 2 and 3 until the pressure stabilizes into the optimal range of 2-3 w.g.
- 5) As the filters age, these settings may need to be reversed to keep pressure within the optimal range.

Over-cleaning filters reduces their life, increase emissions, and increase energy costs.

11 Preventive Maintenance and Troubleshooting

Your Air Hawk requires minimal maintenance. To maximize the lifetime of your purchase, follow this servicing guide:

11.1 Filter Elements

Replace filters that meet any of the following conditions:

- 2 years old
- Damaged by environmental conditions, such as by moisture or high heat.
- Cleaning does not achieve a w.g. level of 6 inches or greater.
-

The pressure drop across filter elements increases quickly when the filters are new or clean. After use, the pressure drop increases more slowly.

11.2 Hopper

Use the following guidelines to maintain your hopper:

- Always inspect the hopper at the start of each shift.
- Never use the hopper to store material.
- Empty and replace collection containers often.
- Do not overfill containers.
- While the Air Hawk is operating, the slide gate should remain open.

11.3 Fan Motor Lubrication

Improper lubrication of the fan is the most common cause of premature bearing failure in your Air Hawk system. There are two types of fans provided by Diversitech:

- 1) Sealed for life bearings. No maintenance required.
- 2) Grease fittings located on the top and bottom motor. Maintenance required.

It is possible to lubricate the fan while the fan is running for initial lubrication only if safety permits. After the initial lubrication, the fan must not be running. The frequency that bearings need lubrication varies. Use all proper safety precautions when working with fast moving parts. Loose clothes, jewelry, and other things can catch and lead to serious injury or death.

Use the following guidelines to lubricate the fan:

- Lubricate the grease fittings with high-quality NLGI No. 2 or No. 3 multi-purpose ball bearing grease. Ensure that the ball-bearing grease has rust inhibitors and anti-oxidant properties.
- Lubricate the bearings before an extended shutdown or before moving the unit into storage.
- Rotate the motor shaft every month.
- Suggested greases include:
 - a. • Shell Alvania No. 2
 - b. • Mobil Mobilith 22

- c. · Gulf Gulfcrown No. 2
- d. · American-Rykon Premium 2

11.4 Solenoid and Diaphragm Valves

The frequency that solenoid and diaphragm valves need maintenance depends on compressed air quality. Check each valve regularly by putting a small screwdriver or paper clip into the base of the solenoid and pushing upwards.

11.5 Automatic Timer Control

If your Air Hawk comes with an automatic timer, it does not require any routine maintenance. Check that the board is operating and ensure any user-defined settings are correct. Please note that dirt and moisture damages the timer, so check inside the enclosure regularly.

11.6 Cleaning and Repair

Treat the inner and outer surfaces of your Air Hawk like any other painted metal. Visually inspect for corrosion and surface damage regularly.

11.7 Inspection Log

Inspection logs are an important part of ensuring your Air Hawk is regularly maintained to maximize the life of your purchase. Diversitech recommends the following maintenance schedule:

Date _____	Time _____	Inspector _____					
DAILY							
Check Controller & Pressure Drop	1. Record Differential Pressure (DP)	%g.	%g.	%g.	%g.	%g.	%g.
	2. Are any Control indicators alarms on?	Y/N	Y/N	Y/N	Y/N	Y/N	Y/N
	1. Is timer sequencing correctly?	Y/N	Y/N	Y/N	Y/N	Y/N	Y/N
Walk through system, listen & observe unusual operation	2. Are solenoids & diaphragm valves operating?	Y/N	Y/N	Y/N	Y/N	Y/N	Y/N
	3. Is hopper discharge device (ex. Airlock) operating?	Y/N	Y/N	Y/N	Y/N	Y/N	Y/N
	4. Is dust being removed from system properly?	Y/N	Y/N	Y/N	Y/N	Y/N	Y/N
	5. Any visual stack emissions? Or Opacity meter?	Y/N	Y/N	Y/N	Y/N	Y/N	Y/N
WEEKLY							
Inspect operations - airlock/screw conveyor, diaphragm valves, cartridges, control panel, air lines, etc.	1. Lubricate bearings of screw conveyor/airlock.	□	□	□	□	□	□
	2. Operate diaphragm valves	□	□	□	□	□	□
	3. Are valves operating and in sequence?	Y/N	Y/N	Y/N	Y/N	Y/N	Y/N
	4. Any visible filter cartridge/tube sheet leaks?	Y/N	Y/N	Y/N	Y/N	Y/N	Y/N
	5. Verify accuracy of temperature indicating equip.	□	□	□	□	□	□
	6. Is hopper emptying properly?	□	□	□	□	□	□
Check compressed air lines, including line filters and dryers	1. Record compressed air pressure.	PSIG	PSIG	PSIG	PSIG	PSIG	PSIG
	2. Clean compressed air filter tap.	□	□	□	□	□	□
	3. Check for clogged air lines.	□	□	□	□	□	□
MONTHLY							
Inspect fan operation	1. Is there any corrosion or material build-up on fans?	Y/N	Y/N	Y/N	Y/N	Y/N	Y/N
	2. Check drive belts for wear and tension.	□	□	□	□	□	□
	3. Inspect and lubricate appropriate items.	□	□	□	□	□	□
	4. Inspect housing for corrosion.	□	□	□	□	□	□
Inspect system operation for leaks	1. Any visible filter cartridge/tube sheet leaks?	Y/N	Y/N	Y/N	Y/N	Y/N	Y/N
	2. Check hoses and clamps.	□	□	□	□	□	□
	3. Check access doors/seals for leaks/deterioration.	□	□	□	□	□	□
	4. Check air lines & fittings for leaks.	□	□	□	□	□	□
	5. Check accuracy of indicating equipment.	□	□	□	□	□	□
ANNUALLY							
Inspect system operation for wear, leaks, corrosion, & material build-up	1. Check inlet baffle for wear.	□	□	□	□	□	□
	2. Inspect filter cartridges thoroughly.	□	□	□	□	□	□
	3. Check ducts for material build-up.	□	□	□	□	□	□
	4. Inspect paint, insulation, etc. for corrosion.	□	□	□	□	□	□
	5. Check fan belts tension and wear.	□	□	□	□	□	□
	6. Check airlock/screw conveyor for general wear.	□	□	□	□	□	□
Inspect system for general operation	1. Record pulse duration/delay.						
	2. Perform Bag dye penetrate test.						
	3. Check all hardware connections and visible welds.	□	□	□	□	□	□
	4. Check door gaskets.	□	□	□	□	□	□
	5. Check diaphragm valves for proper operation.	□	□	□	□	□	□

12 Trouble Shooting Guide

510.1 — High Pressure Drop	
Cause	Solution
Cleaning mechanism not properly adjusted	<ul style="list-style-type: none"> • Increase cleaning frequency • Perform off-line cleaning • Check performance of diaphragm and solenoids (repair) • Check performance of timer controller (adjust or repair) • Check compressed air supply (should be 90 - 105 psi)
Control Timer failure	<ul style="list-style-type: none"> • See actions following Timer/Controller Failure • Verify controller is operational • Check for appropriate power connections • Check to see if timer is indexing to all contacts • Check output on all terminals • Check accuracy of Magnehelic Gauge (if applicable)
Pulse Valve failure	<ul style="list-style-type: none"> • Check wiring between controller and solenoid valves • Check tubing between solenoid valves and diaphragms • Check diaphragms (replace or repair) • Check solenoid valves (replace or repair)
Blinding of Filter Media	<ul style="list-style-type: none"> • Check designed airflow against actual airflow, adjust damper accordingly • Check collection point vs. suggested collection points adjust • Minimize excess airflow, use appropriate ducting • Change filter media type (consult Technical Services) • Install overbags to prevent blinding • Perform off-line cleaning • Add more compartments or modules and filter media • Evaluate dust to find correct Air-to-Cloth Ratio (Camfil APC lab)
End of Cartridge service life	<ul style="list-style-type: none"> • Replace cartridges (service life is determined by the application) • Consult After Market Sales (1-866-639-7151)
Improper start up of collector	<ul style="list-style-type: none"> • Restart collector using suggested procedure in manual • Damper fan and slowly open as system starts up • Preheat the collector before start up • Use pre-coat dust to season the cartridges
Moisture in collector	<ul style="list-style-type: none"> • See sections following Moisture in Collector • Check for leaks in collector or ductwork Insulate collector • Purge system after shutdown • Preheat unit before operation • Check compressed air dryer (-40 degree dew point)
Temperature too high	<ul style="list-style-type: none"> • Measure air temperature in collector and compare to design • Use dilution air to reduce temperature in collector • Install alternate media that can tolerate higher temperature
Inlet baffle plugging, causing high velocities	<ul style="list-style-type: none"> • Check to find type of baffle (channels, abrasion resistant inlet velocities, inlet velocities plate, or none) • Remove plugged baffle • Replace baffle with the appropriate style for application • Reduce moisture in the collection system-see above*

System is not purged after shutdown	<ul style="list-style-type: none"> • Keep fan running for 5 to 10 minutes after process is shut down • Insulate the collector if it is to be located outside • Install a bypass line to allow pre-heating of the collection system • Install a heating system inside the collector • Install a moisture resistant or washable cartridges
Wall temperature below dew-point	<ul style="list-style-type: none"> • If the collector is located outside, it must be insulated • Preheat collector before operation • Purge collector after process shutdown • Install a bypass line to allow heating of the system while off-line • Install a heating system inside the collector • Install moisture resistant or washable cartridges
Cold spots through insulation	<ul style="list-style-type: none"> • Locate cold spots and repair insulation • Eliminate direct metal line through insulation • Install moisture resistant or washable cartridges

510.3 — Low Air Pressure

Cause	Solution
Regulator set to low	<ul style="list-style-type: none"> • Adjust regulator to 90-105 psi of compressed air • Install a regulator or gauge on the air header if possible • Consult Customer Service (1-800-479-6801)
Line too small	<ul style="list-style-type: none"> • Compressed Air Supply ¾" minimum supply line for GS10 and under • 1" minimum supply line for everything larger than GS10 • Consult Customer Service (1-800-479-6801)
Compressor too small (for total plan requirements)	<ul style="list-style-type: none"> • Perform a compressed air audit, reduce usage where possible • Repair leaks and reduce unnecessary loss of air • Replace compressor with larger unit • Add another compressor to system
Compressed air consumption too high	<ul style="list-style-type: none"> • Look for leaks in the compressed air system (repair) • Check to make sure air header drain valve is closed • Check to make sure diaphragm is not stuck in open position
Restrictions in compressed air piping	<ul style="list-style-type: none"> • Check compressed air line to be sure it is clean • If a hose is run to the air header, be sure there are no kinks • Check all valves in the line to be sure they are opened completely
Compressed air dryer plugging	<ul style="list-style-type: none"> • Replace desiccant in the dryer • Bypass dryer temporarily • Replace dryer • Consult Compressed Air Supplier

510.4 — Controller Failure

Cause	Solution
Lack of power	<ul style="list-style-type: none"> • Confirm that power is supplied to board, correct if necessary • Confirm that power supplied matches board requirements • Confirm all breakers and switches are in the 'on' position • Check fuse, replace if necessary • Check controls ' on / off switch, turn it to 'on' • Replace control board
Fuse blown	<ul style="list-style-type: none"> • Replace Fuse • Replace control board

Improper wiring	<ul style="list-style-type: none"> • Check to see if timer is indexing to all contacts • Check output on all terminals • Check wiring between controller and solenoid valves (repair) • Check power connections to board (correct if necessary) • Confirm the type of controller used and refer to appropriate section in this manual or the controller manual
Improper programming	<ul style="list-style-type: none"> • Confirm the type of controller used and refer to appropriate section in this IOM manual or the controller manual • Confirm accurate number of terminals wired into the control board • Confirm designed High and Low set points (adjust accordingly)
Bad control board	<ul style="list-style-type: none"> • Replace board; consult replacement part list for correct part number • Consult Aftermarket (1-866-639-7151)
Bad magnehelic gauge (if applicable)	<ul style="list-style-type: none"> • Confirm accuracy of the gauge, adjust as necessary • Sensor hoses are backwards, switch connections of tubing • Replace Magnehelic gauge; see replacement parts list for correct part number • Consult Aftermarket (1-866-639-7151)
Moisture or contamination in control box	<ul style="list-style-type: none"> • Confirm that the controller housing door has been shut • Confirm NEMA rating of housing and upgrade if necessary • Remote mount controller away from the dust collector
Vibrations causing failure	<ul style="list-style-type: none"> • Locate controller indoors • Consult Customer Service (1-800-479-6801) • Remote mount controller away from the dust collector

510.5 — Dust Bridging in Hopper

Cause	Solution
Dust Stored in hopper	<ul style="list-style-type: none"> • Keep the slide gate or discharge open at all times • Remove dust continuously • Keep rotary airlock and screw - conveyors running • Store collected dust in drums, bags, or bins instead of hopper • Install bin - level indicator
Rotary airlock malfunction	<ul style="list-style-type: none"> • Confirm the airlock speed for application, make adjustment • Check for correct rotation of blades, reverse direction if necessary • Lubricate bearings or motor if applicable • Replace bearings or motor if applicable • Replace gasket or caulk on hopper flange • Confirm correct application of airlock - replace if necessary • Refer to airlock manual for further information • Consult airlock manufacturer
Screw conveyor malfunction	<ul style="list-style-type: none"> • Confirm screw conveyor speed for application, make adjustment • Increase the conveyor opening by making it wider and flared • Lubricate bearings or motor if applicable • Replace bearings or motor if applicable • Replace gasket or caulk on hopper flange • Confirm correct application of conveyor, replace if necessary • Refer to screw conveyor manual for further information • Consult screw conveyor manufacturer

Moisture in collector	<ul style="list-style-type: none"> • See sections following Moisture in Collector • Assure that only dry compressed is used, install air dryer • Insulate collector if it is located outside • Preheat the collector before operation • Purge the collector of all high humidity process air after operation • Inspect and repair any leaks in the collector or ducting • Prevent scalping of moisture from process • Move collector indoors • Install compressed air purge (air sweep) equipment • Install bin-level indicator
Discharge opening too small	<ul style="list-style-type: none"> • Install compressed air purge (air sweep) equipment • Install hopper with larger discharge opening • Install bin-level indicator
Hopper slope insufficient	<ul style="list-style-type: none"> • Install compressed air purge (air sweep) equipment • Install hopper with increased hopper angle • Install bin-level indicator
510.6 — Media Failure	
Cause	Solution
End of cartridge service life	<ul style="list-style-type: none"> • Replace cartridges (service life determined by application) • Consult Aftermarket (1-866-639-7151)
High pressure drop	<ul style="list-style-type: none"> • See sections following High Pressure Drop • Check and adjust cleaning mechanism • Increase air pressure to cleaning mechanism • Check and repair diaphragm valves • Check, program, and repair timer / controller • Check and correct any inlet plugging • Check and reduce moisture present • Check temperature, use appropriate media or use dilution air • Change media area or media type • Perform off-line cleaning • Check fan speed and damper accordingly • Install overbags to prevent blinding • Confirm appropriate location of pickup points and hoods • Add more compartments or modules
Moisture / Water Present	<ul style="list-style-type: none"> • See sections following Moisture in Collector • Assure that only dry compressed is used, install air dryer • Insulate collector if it is located outside • Preheat the collector before operation • Purge the collector of all high humidity process air • Inspect and repair any leaks in the collector or ducting • Prevent scalping of material from process by adjusting system • Move collector indoors
Temperature too high	<ul style="list-style-type: none"> • Measure air temperature in collector and compare to design • Use dilution air to reduce temperature in collector (change fans) • Install alternate media that can tolerate higher temperatures

Application too abrasive	<ul style="list-style-type: none"> • Replace baffle plate with abrasion resistant material • Reduce velocity of inlet air, damper fan • Install filter cartridges of different media type • Install additional modules to reduce Air-to-Cloth ratio • Confirm appropriate location of pickup points and hoods • Install pre-filter to collect larger particles (Cyclone or Drop-out module)
Conveying velocity too great	<ul style="list-style-type: none"> • Reduce airflow, damper fan if possible • Confirm appropriate location of pickup points and hoods • Minimize excess air flow, use appropriate ducting • Change media area or media type • Perform off-line cleaning • Change inlet baffle design (solid strike plate, perforated, etc.) • Add more compartments or modules
Compressed air too high during pulsing	<ul style="list-style-type: none"> • Regulate pressure to 90-105 psi of compressed air • Install a pressure gauge on air header to monitor supply pressure
Inlet air not properly baffled	<ul style="list-style-type: none"> • Install correct baffle (channel, abrasion resistant plate) • Replace channel baffle with abrasion resistant material
Channel baffle worn or missing	<ul style="list-style-type: none"> • Replace channel baffle • Replace channel baffle with abrasion resistant material

510.7 — Poor Efficiency

Cause	Solution
End of cartridge service life	<ul style="list-style-type: none"> • Replace cartridges (service life determined by application) • Consult Aftermarket (1-866-639-7151)
Insufficient filter cake formation	<ul style="list-style-type: none"> • Use pre-coat dust for start-up • Check for adequate airflow at collection points and hoods (adjust) • Allow more time for collector to build dust cake; it may take weeks • Reduce cleaning frequency • Change media type or surface area in filter cartridge • Use pre-coat to assist in the capture of other forms of dust
Wrong filter media used	<ul style="list-style-type: none"> • Replace cartridges with correct filter media for application
Cleaning cycle too frequent	<ul style="list-style-type: none"> • Check programming on controller and adjust accordingly • Check and calibrate Photohelic or Magnehelic gauge • Increase the amount of time between pulse events • Increase the "high" set point on the collector • Refer to the appropriate section in manual for your type of controller
Leaking of cartridges	<ul style="list-style-type: none"> • Check for puncture in media, see sections following Media Failure • Perform a colored trace dust test to discover the source of leak • Check for leaking gaskets, clean tube sheet to assure good seal • Check temperature, use appropriate media or use dilution air • Change media type or total area in cartridges • Check for abrasion
Temperature too high	<ul style="list-style-type: none"> • Measure air temperature in collector and compare to design • Use dilution air to reduce temperature in collector • Install alternate media that can tolerate higher temperature

Leaking gaskets	<ul style="list-style-type: none"> • Confirm correct placement of cartridges, prevent ramping of filters • Confirm locking mechanism is in the closed position • Remove filters and clean tube sheet to assure a good seal • If cam-bars are not bent, replace support brackets for cam-bars • Replace cartridges
Cartridge cam-bars not sealing	<ul style="list-style-type: none"> • Confirm correct placement of cartridges, prevent ramping of filter • Confirm locking mechanism is in the closed position • If cam-bars are bent, replace cam-bars

510.8 — Poor Airflow

Cause	Solution
Fan malfunction	<ul style="list-style-type: none"> • Check to see if the fan is turned to the "on" position • Check required fan power requirement vs. what is supplied • Check that power supply is "hot" • Incorrect wheel rotation, correct motor wiring • Damage to fan wheel - replace wheel • Wheel mounted backwards on shaft, rotate wheel orientation • Temperature too high, replace motor for one better suited • Bent shaft, replace shaft • Broken or damaged belt; adjust, repair, or replace belt • Build-up of dirt or dust, clean fan • Bad or damaged bearings; lubricate, repair or replace bearings • Confirm correct motor starter is used • Check condition and repair the motor starter • Check that all fuses and switches are operational • Check for faulty wiring or shorts in wiring • Consult the fan manufacturer • Replace fan/motor if necessary • Refer to appropriate fan manual
Fan sized incorrectly	<ul style="list-style-type: none"> • Take airflow readings and compare to the design of application • Evaluate fan performance (fan curve) vs. design of application • Replace fan with larger or smaller unit, depending on application
Motor Overloads	<ul style="list-style-type: none"> • Speed set too high on motor, slow motor down • Fan over capacity, replace with larger fan • Density of gas/dust above design, replace with larger fan • Wrong direction of wheel rotation, rotate wheel orientation • Shaft bent, repair or replace • Poor alignment, realign motor and housing • Bind on wheel in housing, repair and realign motor and housing • Bearing wear; lubricate, repair or replace bearings • Temperature too high, replace motor for one better suited • Build-up of dirt or dust, clean fan • Short in wiring, repair or rewire fan • Defective motor, replace • Consult fan manufacturer

Plugged cartridges	<ul style="list-style-type: none"> • See sections following High Pressure Drop • End of cartridge service life, replace cartridges • Check and clean pulsing mechanisms • Increase compressed air pressure or volume • Eliminate moisture in collector • Check and repair the timer / controller • Inspect and clean inlet baffles • Perform off-line cleaning of filter cartridges • Install overbags • Add more compartments or modules and filter media • Increase filter media area or change filter media type
Air leaks in the collection system	<ul style="list-style-type: none"> • Repair or replace any damaged ductwork or collection hoods • Replace missing screws, bolts, gaskets, or caulk • Seal any holes or punctures in the system • Damper any unused collection points
Duct sized incorrectly	<ul style="list-style-type: none"> • Perform a system balance to discover possible problems • Review duct design, adjust blast gates to designed settings • Rework ducts to achieve desired performance • Poor inlet or outlet design, redesign for optimal performance • Install new blower to compensate for poor airflow • Consult installer of ductwork
Collection point incorrectly positioned	<ul style="list-style-type: none"> • Reference: Industrial Ventilation — A Manual of Recommended Practice • Resize duct according to industrial standard • Change hood type to improve collection performance • Reposition collection point or hood to improve performance • Consult installer of ductwork

510.9 — Abnormal Noise

Cause	Solution
Normal noise level of fan operation	<ul style="list-style-type: none"> • Most Camfil APC provided fans range from 89 to 99 decibels • To reduce sound levels, install a fan silencer - Call Customer Service for a Quote. • Enclose fan in a foam lined housing • Enclose the entire collector inside a separate room • Relocate the collector away from production areas • Consult manufacturer of fan
Vibrating or resonance of ductwork	<ul style="list-style-type: none"> • Support and brace ductwork, or improve existing supports • Tighten flanges between the collector and the ductwork • Tighten flanges between the fan and the ductwork • Re-apply gaskets or caulk all the flanges • Place rubber padding between ductwork and support structures • Adjust fan speed and setting to minimize vibrations • Consult ductwork installer
Housing of fan vibrating	<ul style="list-style-type: none"> • Damaged wheel, replace or repair wheel • Damaged housing, replace or repair housing • Broken or loose belt, repair or replace belt • Worn coupling, replace coupling • Broken or loose bolt or screws, replace or tighten bolts and screws • Unstable foundation or supports, tighten or shim housing

Fan impeller hitting the inlet of the fan	<ul style="list-style-type: none"> • Balance or adjust fan wheel • Consult manufacturer of fan
Bad bearings in the fan	<ul style="list-style-type: none"> • Lubricate bearings • Replace bearings • Consult manufacturer of fan
Constant "Hissing" sound	<ul style="list-style-type: none"> • Compressed air being lost, check compressed air line connection • Diaphragm stuck open, check and repair diaphragm • Check for air leak into system • Check drain valve on air header, close if necessary
Rotary airlock or screw conveyor noise	<ul style="list-style-type: none"> • Tighten screw or blade on device • Tighten screw trough or airlock to hopper discharge flange • Re-apply caulk or gasket to flanges • Lubricate bearings in device • Replace bearings in device • Consult manufacturer of rotary airlock or screw conveyor
Electric "Humming" sound	<ul style="list-style-type: none"> • Defective starting relay, replace relay • Replace motor starter • Consult manufacturer of motor starter

510.10 — Repeat Fires or Explosions

Cause	Solution
Dust is explosive	<ul style="list-style-type: none"> • Consult Camfil APC and install the required life safety measures as prescribed in NFPA 654: Standard for the Prevention of Fire and Dust Explosions from the Manufacturing, Processing, and Handling of Combustible Particulate Solids.
Dust is flammable	<ul style="list-style-type: none"> • Consult Camfil APC and install the required life safety measures as prescribed in NFPA 654: Standard for the Prevention of Fire and Dust Explosions from the Manufacturing, Processing, and Handling of Combustible Particulate Solids. • Control sources of ignition, open flames, sparks etc. • Install a sprinkler system inside the collector • Install a spark control device, arrester, trap, or detect and quench system • Install a high efficiency Cyclone or drop out box to catch sparks • Install a fire protection system in the duct work • Use only explosion resistant fan & discharge devices (NEMA-7/9) • Controller housing should be rated NEMA 7/9 • Install fire resistant filter cartridges
Process generates sparks	<ul style="list-style-type: none"> • Install a spark control device, arrester, trap, or detect and quench system • Install a high efficiency Cyclone or drop out box to catch sparks • Install a sprinkler system inside the collector • Install a fire protection system in the ductwork • Use only explosion resistant fan & discharge devices (NEMA-7/9) • Controller housing should be rated NEMA 7/9 • Minimize flame or sparks in process • Install fire resistant filter cartridges

510.11 — Installation Problems

Cause	Solution
Missing Parts	<ul style="list-style-type: none"> • Reference packing slip and inventory items (report missing items) • Loose parts will be shipped in a box placed inside the inlet plenum • Thoroughly check all boxes before discarding

Legs & cross-braces do not match holes	<ul style="list-style-type: none"> • Consult manufacturing drawings for correct arrangement • Re-drill braces to match leg bolt holes • Re-drill legs to match cross-brace bolt holes • Contact Camfil APC to replace cross-braces
Bin vent flange doesn't match hopper	<ul style="list-style-type: none"> • Bin vent or hopper misaligned, rotate plenum 180 degrees, install per match line stickers • Wrong assembly procedure, insert bolts in corners, work to center • Use alignment pins to match flanges during assembly • Drill and tap new holes to match corresponding flange • Flange bent during shipping, replace hopper
Fan flange does not match top panel bolt pattern (top mount fans only)	<ul style="list-style-type: none"> • Wrong top panel, replace panel (if Camfil APC provided fan) • Drill or cut flange into blank top panel (if other than Camfil APC fan) • Use alignment pins to match flanges during assembly • Fan misaligned, rotate fan until flanges match
Hopper flange doesn't match discharge device flange	<ul style="list-style-type: none"> • Discharge device misaligned, rotate to match hopper flange • Wrong assembly procedure, insert bolts in corners, work to center • Use alignment pins to match flanges during assembly • Drill and tap new holes to match corresponding flange • Flange bent during shipping, replace hopper • Consult manufacturer if other than a Camfil APC discharge device
Controller does not operate	<ul style="list-style-type: none"> • See section following Controller Failure • Check for correct power supplied to control board (correct) • Check for off switches, breakers, or blown fuses (replace or correct) • Check for improper wiring, correct as needed • Bad control board, replace if necessary • Consult Customer Service (1-800-479-6801)
Collector leaks dust	<ul style="list-style-type: none"> • Locate and seal any dust leakage points in the collector • Caulk any leaking flanges or panels • Insert any missing bolts or fittings • Replace door gaskets if leaking • Check and repair door lock mechanism if necessary • Weld or caulk any holes or gaps in welded seams
Air header leaks	<ul style="list-style-type: none"> • Check drain plugs, close if open • Check and repair diaphragm valves • Check connection to compressed air supply line, repair if necessary

Heavier dust loading than design (scalping of product)	<ul style="list-style-type: none"> Check designed airflow against actual airflow, adjust damper accordingly Check collection point vs. suggested collection points (adjust) Minimize excess airflow, use appropriate ducting Minimize overfeeding of process equipment Change filter media type (consult Tech. Services) Install over-bags to prevent blinding Perform off-line cleaning Add more compartments, modules or filter media
Collector undersized (high air to cloth ratio)	<ul style="list-style-type: none"> Check fan damper and fan speed, adjust accordingly Minimize excess airflow, use appropriate ducting Confirm appropriate location of pickup points and hoods Change filter media type (consult Tech. Services) Collector undersized Install overbags to prevent blinding Perform off-line cleaning Add more compartments, modules or filter media Evaluate dust to find correct air to cloth ratio (Camfil APC lab)

510.2 — Moisture In Collector

Cause	Solution
Leaks in the collector and ducting	<ul style="list-style-type: none"> Check ductwork on inlet and outlet to assure good caulking Check ductwork on inlet and outlet to assure tightened bolts Check frame and panels caulking (re-caulk if necessary) Check frame and panels for tightened bolts (replace or tighten) Leaks in the collector Check ductwork for any leaks or punctures (repair or replace) Check door gasket for leaks (repair or replace) Install moisture resistant or washable cartridges Check hopper flange at corners and seam of module Check double or triple inlet where bolted to seam on multiple frames
Water or moisture in compressed air supply	<ul style="list-style-type: none"> Open drain valve on air header to see if water comes out Check to see if compressed air supply has an air dryer installed Verify air dryer is rated for -40 degree dew point Replace desiccant in the dryer Replace dryer Install timed drain valve on header
Scalping of process moisture (processes using water - i.e. Banbury Mixer)	<ul style="list-style-type: none"> Check designed capture velocity of hood vs. actual (adjust) Check designed location of collection point vs. actual (relocate) Reduce airflow at collection point Minimize water overflow in process equipment if possible Move the collection point of process if possible Install moisture resistant or washable cartridges
Insufficient preheating	<ul style="list-style-type: none"> Run the system with hot air before process gas flow is introduced Insulate the collector if it is to be located outside Install a by-pass line to allow pre-heating of the collection system Install a heating system inside the collector Install moisture resistant or washable cartridges

Definitions

Abrasion Resistance

The ability of a fiber or fabric (media) to withstand surface wears.

ACFM

Actual cubic feet of gas per minute. The volume of gas flowing per minute at the operating temperature, pressure, elevation and composition.

Air-to-Cloth Ratio

The ratio between ACFM flowing through a dust collector and the square feet of filter area available (ACFM/Ft²). Sometimes referred to as the velocity of air through the cloth.

Blinding

Blockage in a fabric or media by dust that cannot be discharged by the cleaning mechanism, resulting in a reduced gas flow and an increased pressure drop across the media. Once enough material has built up, airflow is severely restricted and the bags have to be cleaned or replaced.

Brownian Movement

Sub-micron particles are diffused, increasing the probability of contact between the particles and collecting surfaces.

Bridging

Material handling problem characterized by the particulate forming a cavity over the discharge or opening of a hopper or storage vessel. Also, the accumulation of collected dust between two or more filter elements.

Can Velocity

In a dust collector with the filter elements suspended from the tube sheet, "can velocity" is the upward air stream speed calculated by dividing the open cross sectional area of the dust collector (less the area of the filter bottom) into the full volume of the exhaust fan (ACFM/Ft² = Feet per Minute), Ref. Interstitial Velocity. Note: This does not apply to the Diversitech Air Hawk because of the cross flow design.

Clean Air Plenum

The dust collector area, through which gases are directed, located on the clean side of the filter media.

Collection Efficiency

The measure of a dust collector's ability to remove particulate from the inlet gas, typically expressed in percent or emission rate (grains per cubic foot).

Dew point

The temperature at which condensation begins to form as the gas is cooled.

Diaphragm Valve

A compressed air valve operated by a solenoid valve that opens to allow a pulse to a series of filters.

Differential Pressure

The change in pressure or the pressure drop across a device. The difference between static pressures measured at the inlet and outlet of a device, Ref. Pressure Drop.

82

Dust Cake

A dust build-up on the filter elements that increases the efficiency of the filter media.

Dust Loading

The weight of solid particulate suspended in an air stream, usually expressed in grains per cubic foot (or grams per cubic meter).

Electrostatic Forces

The presence of an electrostatic charge on the particles and the filter can increase dust capture.

Emissions

Particulate that escapes through or around a dust collector into the atmosphere.

Fan

A device for moving air and dust through a ventilation system. If the fan is on the dirty air side of the collector, it is called a positive system. If the fan is on the clean air side of a collector, it is called a negative system.

Filter Media

The air permeable material utilized in a dust collector, which provides a barrier to remove dust from the air stream.

Hopper

The section of a dust collector located below the dust collector housing utilized for the accumulation and discharge of the collected dust.

Impingement

The physical contact of a dust-laden gas flow against a filter media. Typically referred to the abrasive wear caused by this impact.

Inches of Water

A unit of pressure equal to the pressure exerted by a column of water one inch high at standard conditions (70OF @ sea level), usually expressed as inches water gauge ("w.g.) or inches water column ("w.c.).

Interstices

The openings or voids in a filter media. In addition, the openings or voids between filter elements.

Interception

Particles that do not cross the fluid streamlines come in contact with the fibers because of the fiber size.

Inertial Collection

Dust particles strike the fibers placed perpendicular to the airflow direction instead of changing direction with the air stream.

Interstitial Velocity

Velocity of a gas as it passes between a compartment of filter elements calculated at its highest value, Ref. "Can Velocity" for formula. Note: This does not apply to the Diversitech Air Hawk because of the cross flow design.

83

Magnehelic Gage

An instrument used to measure differential pressure drop.

Manometer

A U-shaped tube filled with a specific liquid. The difference in height between the liquid in each leg of the tube gives the difference in pressure on each leg of the tube. Used to monitor differential pressure.

Micron (μm)

A unit of length, 1/1000th of one millimeter (1/24,000th of an inch).

Negative Pressure System

A system where the fan is located after the dust collector on the clean air side, pulling air through the system.

OEM

Original Equipment Manufacturer.

Particulate

Any airborne solid material.

Permeability

A measure of fabric porosity or openness, expressed in cubic feet of air per minute per square foot of fabric at a 0.5" w.c. pressure differential.

Photohelic Gauge

An instrument used to measure the differential pressure drop and to initiate the cleaning system by means of adjustable “high” and “low” set points for automatic actuation of a sequential timer.

Positive Pressure System

A system with a fan located prior to a dust collector on the dirty side, pushing air through the system.

Precoat

Material added to the air stream at start-up to aid in establishing the initial dust cake on the filter media.

Pressure Drop

A measure of the resistance the gas stream encounters as it flows through the system. It may be referred to as pressure differential across the media, across the dust collector, or the pressure drop across the entire system, depending upon the points of measurement.

Pulse Cycle

The interval of time between pulsing one row of filters and pulsing that row again.

Pulse Duration (On-Time)

The length of time a pulse lasts, generally described as the length of time the electrical signal holds the solenoid pilot valve open.

Pulse Delay (Off-Time)

Elapsed time between pulses in a dust collector cleaning system.

84

Pulse Clean Dust Collector

A dust collector using short intermittent pulses of compressed dry air to clean dust from the filter media.

Re-entrainment

The phenomenon where dust is collected from an air stream and is then returned to the air stream. This occurs when dust is dislodged from a filter media during cleaning and is again captured by the same or an adjacent filter media.

Rotary Airlock Valve

Device having a star wheel (rotor) designed to provide an air tight seal between the negative or positive pressures of the collector and the outside atmosphere.

Screw Conveyor

A revolving screw operating in a fixed trough for conveying material from one point to another. Note: Should a screw conveyor be used in a dust collector system, an airlock is still required to ensure ventilation air does not pass through the conveyor.

SCFM

Standard cubic feet per minute. The volume of gas flow per minute at standard temperature and pressure conditions (70OF @ sea level).

Solenoid Valve

An electromechanical plunger device that is either “normally open” or “normally closed”. In use with a dust collector, it is for the relief of air pressure to activate a compressed air device such as a diaphragm valve.

Timer, Sequential

An electrical mechanism that activates a dust collector’s cleaning system.

Tube sheet

A steel plate on which the open end of the filter elements are connected. This wall separates the clean air and dirty air plenums of the dust collector.

LIMITED EQUIPMENT WARRANTY

For a period of 2 years from the date of purchase, all Diversitech products are warranted to be free from defects in material, workmanship, and construction, when used in accordance with installation, maintenance instructions, and expressly stated proper use application(s). Diversitech Inc. will repair or replace, at our option, any defective parts which fail during the warranty period. This warranty is limited to replacement parts ONLY, and does not cover personal liability, property loss, normal wear; and does not cover losses resulting from (or due to) improper installation, inadequate maintenance, misapplication, misuse, or use above rated capacities.

For a period of 12 years from the date of purchase, the chassis segment is warranted to be free from defects in material, workmanship, and construction, when used in accordance with installation, maintenance instructions, and expressly stated proper use application(s). Diversitech Inc. will repair or replace, at our option, any defective parts which fail during the warranty period. This warranty is limited to replacement parts ONLY, and does not cover personal liability, property loss, normal wear; and does not cover losses resulting from (or due to) improper installation, inadequate maintenance, misapplication, misuse, or use above rated capacities.

FREIGHT CLAIMS

Shipments must be inspected upon arrival. All Diversitech units are sold ex-plant. Therefore, it is the receiver's responsibility to file any freight claims with the carrier for obvious or concealed damages. Damaged shipments must be refused at time of receipt, by consignee.

RETURN MATERIAL POLICY

Prior to the return of material, for whatever reason, a return manufacturing authorization number (RMA#) is required from the Diversitech customer service department. This procedure is necessary for proper control and handling of returned materials. Call 1-800-361-3733 or email support@diversitech.ca to obtain an RMA.

All material must be returned prepaid. Credit will be given for returns for warranty repair or replacement. Freight collect shipments, or freight without an RMA, will not be accepted. It is the shipper's responsibility to ensure that material being returned to Diversitech is adequately packaged for shipment to preclude damages.



Visit our Website for more information on this product
www.diversitech.ca

1200 55th Avenue, Montreal
Quebec H8T 3J8
Email: info@diversitech.ca